

INFINITY *id2*

INTELLIGENT 2 WIRE FIRE DETECTION SYSTEM WITH 'ID' TECHNOLOGY



INSTALLATION MANUAL



CONTENTS

1. SAFETY INFORMATION.....	3
1.1 Installation Information	3
1.2 Safety Precautions during Normal Operation of Panel	3
1.3 Battery Information	3
1.4 Product Disposal at the end of its working life	3
2. PRODUCT DESIGN INFORMATION	4
2.1 Fire Alarm Control Section	4
2.2 Power Supply Section.....	4
2.3 Environmental.....	4
3.0 Panel description & design concept.....	5
4 USING THIS MANUAL	6
4.1 Equipment guarantee	6
5 DESIGNING A SYSTEM	7
5.1 Designing a ID2 System	7
6. INSTALLING THE SYSTEM	8
6.1 Considerations before Installation	8
6.1.1 MOUNTING THE CONTROL PANEL	8
6.1.2 RECOMMENDED CABLE TYPES AND THEIR LIMITATIONS	8
6.1.3 MAINS WIRING RECOMMENDATIONS	8
6.2 First Fix	9
6.2.1 MOUNTING THE FIRE ALARM PANEL	9
6.2.2 FIXING THE BACK BOX TO THE WALL	9
6.2.3 PLANNING CABLE ENTRY	9
6.2.4 CONNECTING THE MAINS POWER	10
6.2.5 CONNECTING THE BATTERIES	11
7. ZONE WIRING.....	12
7.1 Specific device wiring instructions	13
7.1.1 CP3/AD Manual Call Point.....	13
.....	13
7.1.2 MKII detectors (All types) Base connection	13
7.1.3 ZAI - MI Input Module.....	14
7.1.4 ZAIO – MI Input/output Module	14
7.1.5 ZASC – MI Sounder Control Module	15
7.1.6 ZAZM – MI Conventional Zone Module	15
7.1.7 Xtratone Sounder/Sounder Flasher	16
7.1.8 Sandwich Sounder.....	16
7.1.9 Addressable Remote LED Indicator.....	17
7.2 Setting the device zone & ID (detectors, call points & sounders).....	18
7.3 LOOP MODE - MAXIMUM LOOP LENGTH RECOMMENDATIONS	20
8 SOUNDERS	21
9. AUXILIARY OUTPUTS.....	21
9.1 Auxiliary output wiring.....	21
10. FIELD DEVICE TERMINATION	22
10.1 Terminating the wiring.....	22
11 OTHER CONNECTIONS	22
11.1 Repeater connection.....	23
12. CONFIGURING THE ID2 FIRE ALARM PANEL	24
12.1 CONFIGURING THE ZONES	24
12.1.1 FROM A BLANK INFINITY ID2 PANEL	24
12.1.2 FROM A PREVIOUSLY CONFIGURED PANEL	24
12.2 Verifying the Zone configuration	24
12.3 Labelling the Panel and Zones	25
12.4 Labelling the Devices.....	25
12.5 Setting time and date.....	25

12.6 Changing the alarm Tones - sounders.....	25
12.7 CHANGING FIRE RELAY RESPONSE	25
12.8 CHANGING INPUT/OUTPUT INTERFACE RESPONSE	25
12.8.1 DEFAULT SETTING	25
12.8.2 SETTING INDIVIDUAL I/O UNIT OPERATION - RELAY	26
12.8.3 SETTING INDIVIDUAL I/O UNIT OPERATION - INPUT.....	26
12.8.4 I/O UNIT OPERATION - PANEL LINK.....	26
12.8.5 CONFIGURING ALARM OUTPUT RESOUND OPERATION	27
12.9 Setting the LCD language	27
12.10 Software Versions	27
13 ALARM VERIFICATION.....	28
13.1 Alarm Verification Options.....	28
13.1 How Alarm Verification Works.....	28
13.2 Setting the Alarm Verification Delay.....	28
13.3 Applying Alarm Verification Delay to a detector	28
14 RESTORING THE PANELS DEFAULT SETTINGS	29
15 VIEWING PANEL INFORMATION	30
15.1 Menu Structure	30
15.2 Viewing device status.....	31
15.3 Locating a device.....	31
15.4 Using the event log	32
16. THE FIRE ALARM CONDITION	33
16.1 Viewing a fire alarm event	33
16.2 Viewing Faults during a fire alarm condition	33
16.3 Viewing Zone Disablements during a fire alarm condition	33
16.4 Viewing Device Disablements during a fire alarm condition	33
16.5 Viewing Zones in Test Mode during a fire alarm condition	33
17. DISABLEMENT	34
17.1 Zone disablement	34
17.2 To programme zone (or sounders) as disabled.....	34
17.3 Device disablement.....	35
17.4 Viewing disablements.....	35
17.4.1 VIEWING DISABLED ZONES	35
17.4.2 VIEWING DISABLED DEVICES.....	35
18. TEST MODE	36
18.1 Why use test mode	36
18.2 To programme zone in test mode.....	36
18.3 To program sounder circuits in test mode.....	36
19. GENERAL FAULT FINDING	37
19.1 Common fault	37
19.2 Zone contents fault finding.....	37
19.3 Zone faults	37
19.4 Supply faults.....	38
19.5 Earth faults.....	38
19.6 Double address	38
19.7 System fault	39
20.1 Standby battery calculation	40
20.2 Device Values for Battery calculation	40
20.3 Example battery calculation.....	41
21. PCB TERMINATION CONNECTIONS.....	42
22 SPECIFICATIONS	43
22.1 Enclosure specifications	43
22.2 Electrical specifications	43

1. SAFETY INFORMATION

WARNING: *Read this section completely before commencing installation.*

1.1 Installation Information

THIS FIRE ALARM CONTROL PANEL IS CLASS 1 EQUIPMENT AND MUST BE EARTHED

This equipment must be installed and maintained by a qualified and technically experienced person.

This C.I.E. must be wired to a fused spur rated at 3A. It must **NOT** be connected via a removable plug, or be connected through an RCD device.

Prior to commencing installation of the control panel, ensure that adequate precautions are taken to prevent damage to the sensitive electronic components on the display board and the control board due to electrostatic discharge. You should discharge any static electricity you may have accumulated by touching a convenient earthed object such as an unpainted copper radiator pipe. You should repeat the process at regular intervals during the installation process, especially if you are required to walk over carpets.

The panel must be located in a clean, dry position, which is not subject to excessive shock or vibration and at least 2 meters away from pager systems or any other radio transmitting equipment. The operating temperature range is 0°C to 40°C; maximum humidity is 95%.

HANDLING THE PCB

If the PCB is to be removed to ease fitting the enclosure and cables, care must be taken to avoid damage by static.

The best method is to wear an earth strap, but touching any earth point (eg building plumbing) will help to discharge any static. Always hold the PCB by its sides and avoid touching the legs of any components. Keep the PCB away from damp dirty areas, e.g. in a small cardboard box.

1.2 Safety Precautions during Normal Operation of Panel

NOTE: When the ID2 panel is operating normally, i.e. not being tended by service personnel, the front cover should be screwed closed with the hex screws provided.

1.3 Battery Information

This C.I.E. uses 2 x 12V Sealed Lead Acid (SLA) batteries up to 7 Ah.

CAUTION:
RISK OF EXPLOSION IF BATTERY IS REPLACED BY AN INCORRECT TYPE.

DISPOSE OF USED BATTERIES ACCORDING TO BATTERY MANUFACTURERS INSTRUCTIONS

IMPORTANT NOTES ON BATTERIES:

DANGER: Batteries are electrically live at all times. **NEVER short circuit the battery terminals.**

WARNING: Batteries are often heavy; take great care when lifting and transporting batteries. For weights above 24 kilos, lifting aids should be used.

DANGER: Do NOT attempt to remove the battery lid or tamper with the internal workings of the battery. Electrolyte is a highly corrosive substance, and presents significant danger to yourself and to anything else it touches. In case of accidental skin or eye contact, flush the affected area with plenty of clean, fresh water and seek immediate medical attention.

Valve Regulated Lead Acid (VRLA) batteries are "low maintenance", requiring no electrolyte top-up or measurement of specific gravity.

1.4 Product Disposal at the end of its working life

Like all electronic equipment, at the end of its working life this unit should not be disposed of in a refuse bin. It should be taken to a local reprocessing site as per the guidelines of the WEEE directive, for correct disposal.



2. PRODUCT DESIGN INFORMATION

2.1 Fire Alarm Control Section

The ID2 Fire Alarm Control and Indicating Equipment (CIE) has been designed to EN 54-2:1997 +A1 - Fire Detection & Fire Alarm Systems – Control & Indicating Equipment

As well as meeting the requirements of EN 54-2:1997 +A1, the Infinity ID2 also has the following options with requirements:-

Clause 7.8	Output to fire alarm devices (Option with requirements)
Clause 7.12	Dependencies on more than one alarm signal (Option with requirements)
Clause 8.3	Fault signals from points (Option with requirements)
Clause 9.5	Disablement of addressable points (Option with requirements)
Clause 10	Test Condition (Option with requirements)

The ID2 also has the following ancillary functions not required by the Standard:-

- Serial repeater output (RS485)

2.2 Power Supply Section

The ID2 Fire Alarm Panels Power Supply Equipment (PSE) has been designed to EN 54-4:1997 A1+A2 - Fire Detection & Fire Alarm Systems – Power Supply Equipment.

The PSE has been designed to charge batteries up to 7Ah within the time limits specified by EN54-4.

The PSE will draw a maximum of 25mA from the battery in the event of mains failure.

The PSE is a switching power supply, with a supply rating (IMAX) of 2.0 Amps

The PSE has a 350mA limited charger output

2.3 Environmental

- It will operate in ambient temperatures of –5 to 40°C
- It will operate in a relative humidity of up to 95% (non condensing)
- It will withstand vibrations between 5 & 150 Hz
- The CIE & PSE should be maintained as described in section 3 of the User Manual, Maintenance Guide & Log Book.

3.0 Panel description & design concept

The ID2 is an eight zone intelligent fire alarm control panel designed to EN54 part 2 & 4.

The ID2 has been designed to use zone powered sounders but also has 2 conventional sounder circuits. All sounders on a ID2 panel will activate on any alarm.

It has been designed to give the advantages of an addressable system, with the simplicity of a conventional system. To help achieve this, the ID2 uses default values to cut out many of the programming steps normally associated with addressable panels.

This leaves only the device label to be entered by the installer. This is done with the built in keyboard

4 USING THIS MANUAL

It is beyond the scope of this manual to teach the user all the intricacies of fire alarm system design. If in doubt about what is required, read BS 5839: Pt 1: 2013 "Fire Detection and Alarm Systems for buildings (UK Code of Practice for System Design, Installation, commissioning and maintenance)" available from the BSI, or at your local reference library. Other national regulations will also give similar guidance.

This manual explains, in a step-by-step manner, the procedure for the basic design and installation of the **ID2** range of Fire Alarm Control Panels.

It gives detailed instructions on how to use all the features on this fire alarm panel.

For operational and maintenance information, please refer to document USER MANUAL, MAINTENANCE GUIDE & LOG BOOK. It also contains a System set-up table, and Installation Certificate, that must be completed by the Commissioning Engineer prior to system handover.

Unlike the User Manual, this Installation Manual must not be left accessible to the User.

4.1 Equipment guarantee

If this equipment is not fitted and commissioned according to our guidelines, and the relevant National Standards, by an approved and competent person or organisation, the warranty may become void.

5 DESIGNING A SYSTEM

This manual is not designed to teach Fire Alarm System design. It is assumed that the System has been designed by a competent person, and that the installer has an understanding of Fire Alarm System components and their use.

We strongly recommend consultation with a suitably qualified, competent person regarding the design of the Fire Alarm System. The System must be commissioned and serviced in accordance with our instructions and the relevant National Standards. Contact the Fire Officer concerned with the property at an early stage in case he has any special requirements. If in doubt, read BS 5839: Pt 1: 2013 "Fire Detection and Alarm Systems for buildings (Code of Practice for System Design, Installation, commissioning and maintenance)" available from the BSI, or at your local reference library.

5.1 Designing a ID2 System

Designing a ID2 System is a fairly straight forward matter. It just takes a bit of thought to zone allocation during the system design stage.

1. Decide on the zone allocation for the system. Each default zone can have a maximum of 15 devices fitted. Consider the simplified 3-storey building below.

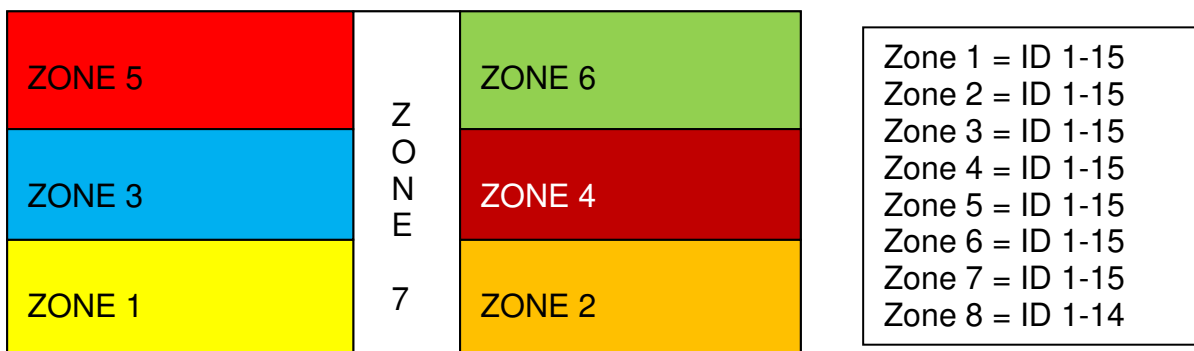

The advantage of this method of zone allocation is that it simplifies the panel setup by eliminating a programming stage.

2. Sounder operation. On the ID2 Panels, it is a common sounders, i.e. an alarm signal from any device will activate all sounders.

If more sophisticated sounder & I/O operation is needed, ask your dealer about the Premier Quatro panel.

3. Whenever possible, give each device as descriptive a label as possible. The better the description, the easier it is to locate in the event of an alarm. The panel allows 20 characters for the device ID, and 16 characters for the zone labels. It may be necessary to use abbreviations to achieve the required label.

4. Keep the design of the system, and any changes to it well documented. This makes it easier to trace any configuration errors during installation & commissioning.

6. INSTALLING THE SYSTEM

6.1 Considerations before Installation

6.1.1 MOUNTING THE CONTROL PANEL

The control panel should be installed in accordance with the following recommendations:-

- The panel should be close to the main entrance of the building, so that it can be viewed by any fire-fighting personnel entering the building.
- It should be fitted to a sturdy wall that will not flex unnecessarily.
- It should be mounted at eye level, in order for it to be viewed without need of a ladder.
- It should be installed in a dry, weatherproof place, preferably NOT in direct sunlight.
- It should be easily accessible, so that the responsible person can perform their regular fire alarm checks.

6.1.2 RECOMMENDED CABLE TYPES AND THEIR LIMITATIONS

All wiring must be installed to meet BS5839: Pt1: 2013 and BS 7671 (Wiring Regs) standards. Other National standards of fire alarm system installation should be adhered to where applicable.

Screened cables should be used throughout the installation to help shield the Panel from outside interference and ensure EMC compatibility.

The two categories of cable according to BS5839: Pt1: 2013, Clause 26 "Fire Detection and Alarm Systems for Buildings (Code of Practice for System Design, Installation and Servicing)" are:

Standard fire resisting cable – to PH30 classification of EN 50200
Enhanced fire resisting cable – to PH120 classification of EN 50200
(Note that all cables should be at least 1mm² cross section)

On the ID2 the general recommendation would be to use standard fire resistant cable, such as Firetuff™, FP200 or any equivalent. These cables are screened, and will provide good EMC shielding when properly grounded at the panel. Certain system specifications may demand the use of a particular type of cable and due regard should be paid to this fact.

Depending on the environment, the cables may need mechanical protection (such as a conduit).

6.1.3 MAINS WIRING RECOMMENDATIONS

The Mains supply to the FACP is fixed wiring, using **Fire resisting** 3-core cable (Between 1 mm² and 2.5mm²) or a suitable 3-conductor system, fed from an isolating double pole switch fused spur, fused at 3A. **IT SHOULD NOT BE CONNECTED THROUGH AN RCD.** This should be secure from unauthorised operation and be marked 'FIRE ALARM: DO NOT SWITCH OFF'. The supply must be exclusive to the Fire Panel. **MAKE SURE ANY SPARE ENTRY HOLES ARE COVERED**

For information on how to connect Mains to the Panel's Power Supply PCB, see page 11. Also refer to rating information on the mains cover inside the FACP.

6.2 First Fix

6.2.1 MOUNTING THE FIRE ALARM PANEL

The ID2 comes with many cable entry holes. If another entry hole is required, it is strongly recommended that the termination PCBs should be removed and stored in a safe place. This would also help while fixing the back box to the wall.

6.2.2 FIXING THE BACK BOX TO THE WALL

Figure 2: Plan view inside the enclosure without PCBs. Side view for surface installation.

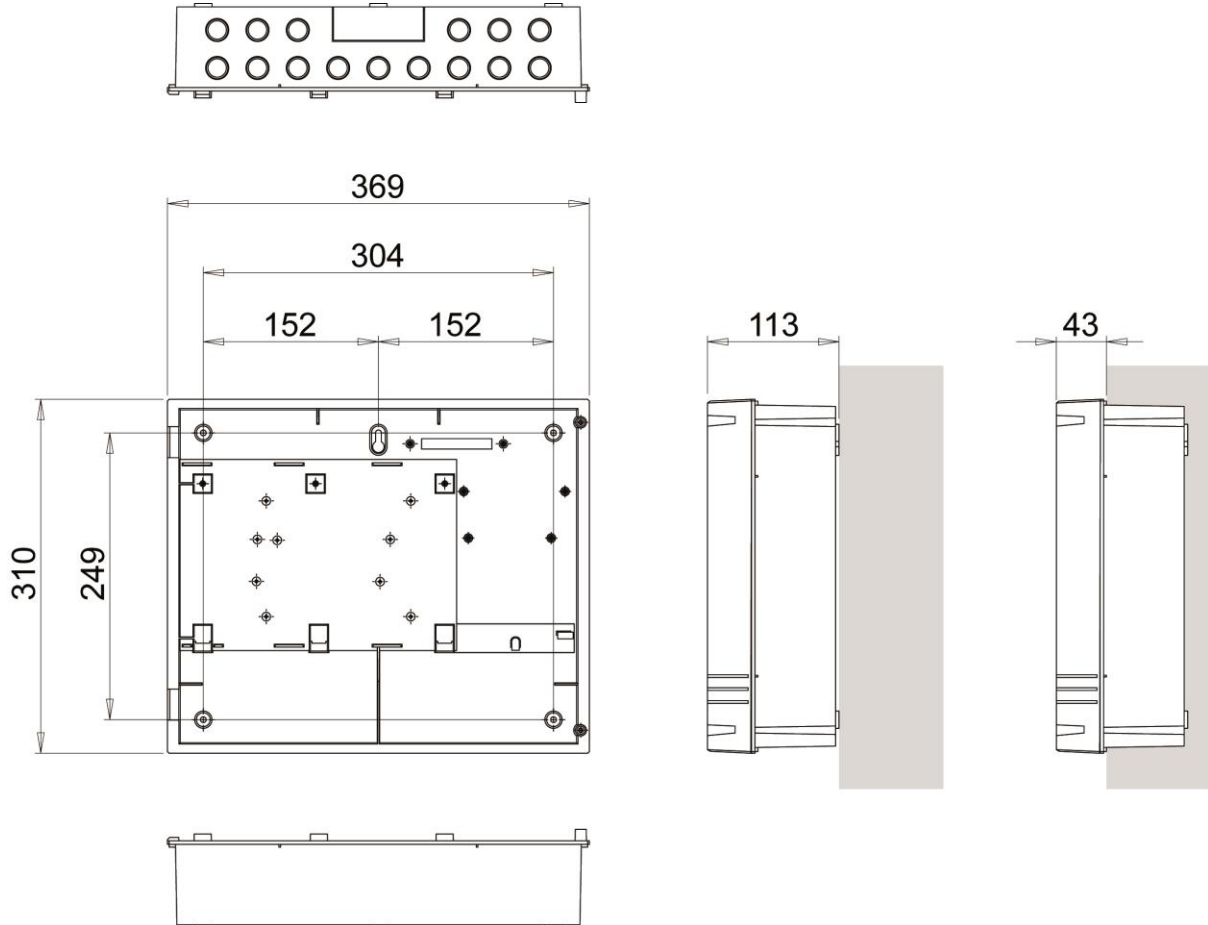

Note that the enclosure has a document tray on the left hand side that holds the panel manuals. If semi flushing or fitting to a tight space, remember to remove the manuals before fitting to the wall.

Fix the enclosure to the wall using the three mounting holes provided.

Check the build & condition of the wall to decide a suitable screw fixing.

The mounting holes are designed for No 8 roundhead or countersunk woodscrews (or similar).

Remove any debris from the enclosure.

Take care not to damage the FACP during installation.

6.2.3 PLANNING CABLE ENTRY

Fig.2 above shows the location of the cable entries to facilitate planning of wiring (home runs) to be brought to the panel.

The 230V a.c. Mains cable must be fed into the enclosure via one of the cable entries at the top right corner of the back box. (Refer to "Connecting the Mains" on Following Page).

6.2.4 CONNECTING THE MAINS POWER

Figure 3: Power Supply PCB layout and Mains connection details

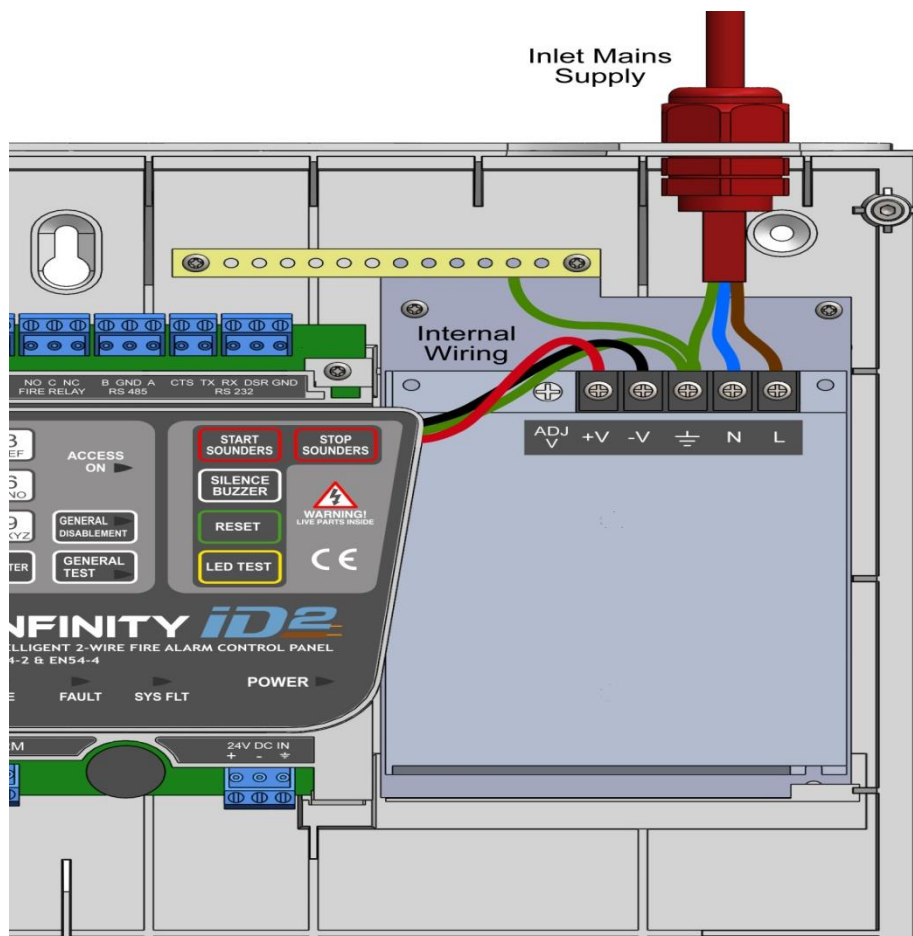

The panel should be connected to 220-240V AC by a 3A rated spur to the fuse box with 1mm² to 2.5mm² 3-core cable. Nothing else should be connected to this supply. The cable should be fire resistant.

Having entered the panel via the cable gland, the mains cable should be passed twice through the provided ferrite. This is made easier by removing the outer insulation. The cable is then connected to the Live, Earth and Neutral connections marked on the power supply cage. The Mains is protected by an INTERNAL fuse on the PSU cage. (This fuse is not user replaceable)

The incoming mains cable should be kept separate from the zone cables to help minimise mains interference.

It is advisable to apply power to the panel before connecting any devices, to check for correct operation, and to familiarise yourself with the fire alarm panels controls.

6.2.5 CONNECTING THE BATTERIES

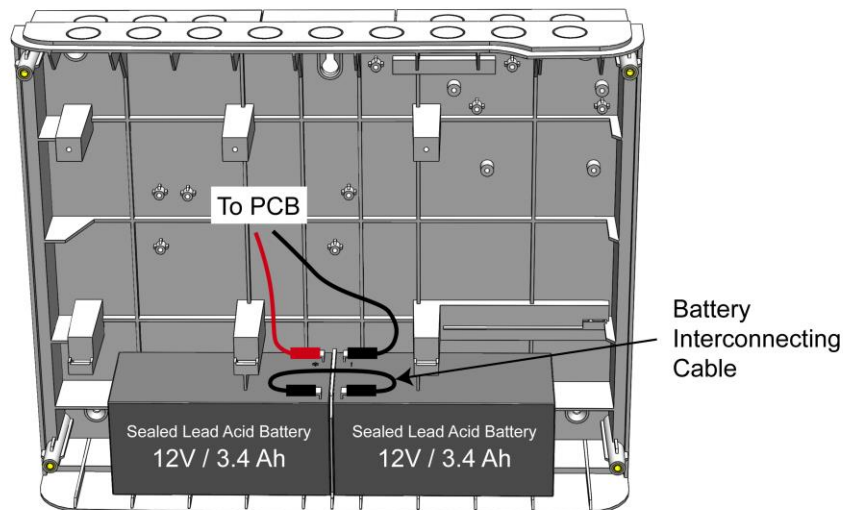

Figure 4: Battery location and connection details

Although there are many sizes of suitable battery, the sizes we usually recommend for the ID2 are 12V 7Ah,

To calculate the exact requirement, use the equation in section 20.1, STANDBY BATTERY CALCULATIONS

The two batteries are wired in **series** to give **24 Volts**.

Connect the **-ve** of Battery 1 to the **black** battery charger lead.

Connect the **+ve** of Battery 2 to the **red** battery charger lead.

The +ve of the first battery is connected to the -ve of the second battery using the battery link wire supplied.

When fitting the batteries, take care not to damage the temperature monitoring thermistor. (Next to the charger lead connections). This is used to prevent overcharging the batteries in high ambient temperatures.

Recommended Batteries

Powersonic PS-1270, 12V, 7Ah (or equivalent)

7. ZONE WIRING

The ID2 can be wired with up to 8 separate radial circuits each with 15 devices per circuit. It may also be wired as a single loop.

When Wired as a Loop, Zone 1 is used as Loop OUT (Side A), and Zone 2 is used as Loop IN (Side B)

Each termination is identified on the terminal labels. The Earthing of the cable screens should be as shown below.

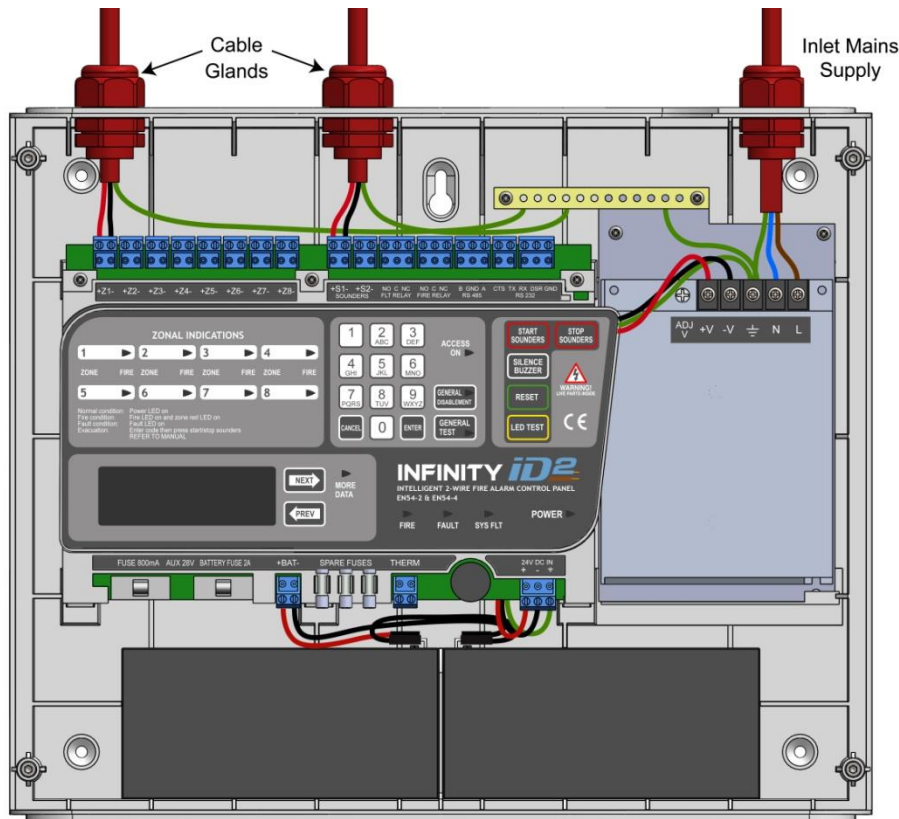

7.1 Specific device wiring instructions

All products will come with their own wiring instructions. This should be used when connecting a product. But as a general guideline, here are the connection details of most Zeta Addressable products.

7.1.1 CP3/AD Manual Call Point

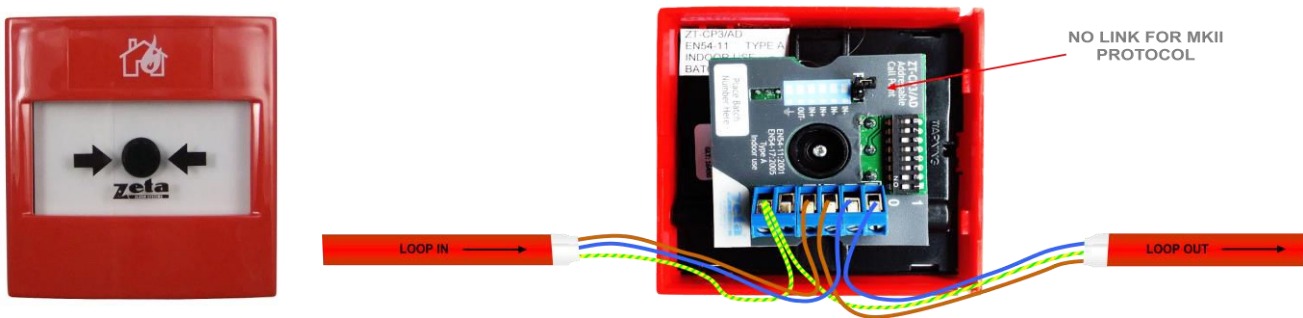

The CP3/AD call point has a built in isolator which can be wired in circuit or not used. This is done by means of not wiring to the negative out terminal on the call point. The following terminals are used for connecting the call point.

- 2 x Negative in terminals (note if you only connect to the negative in terminals then the isolator is bypassed)
- 1 x Positive in terminal
- 1 x Positive out terminal
- 1 x Negative out terminal (note if used puts the isolator in circuit)
- 1 x Earth terminal used to connect the cable screen



7.1.2 MKII detectors (All types) Base connection

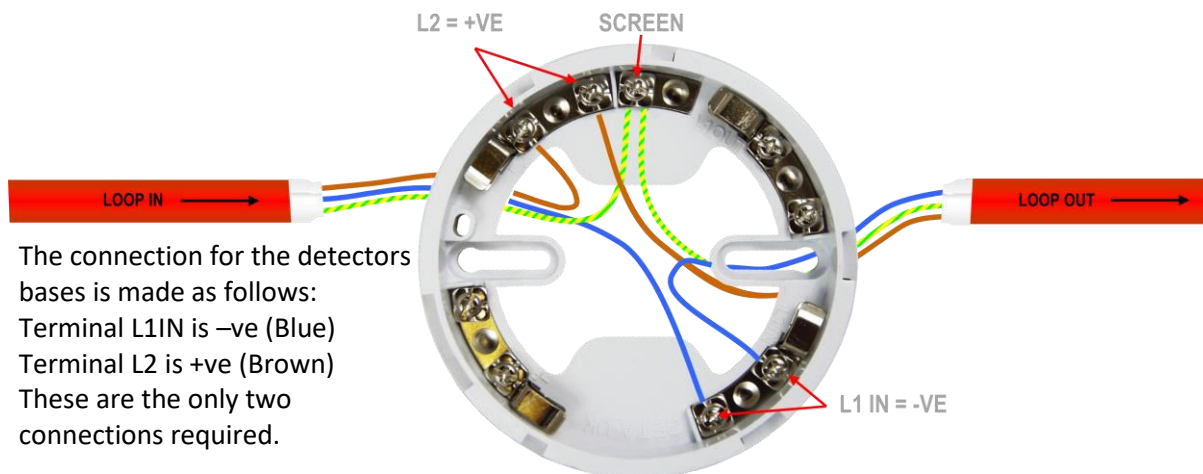

The connection for the detectors bases is made as follows:
 Terminal L1IN is -ve (Blue)
 Terminal L2 is +ve (Brown)
 These are the only two connections required.



Deep Base MKII-CB/D

Common Base MKII-CB

7.1.3 ZAI - MI Input Module

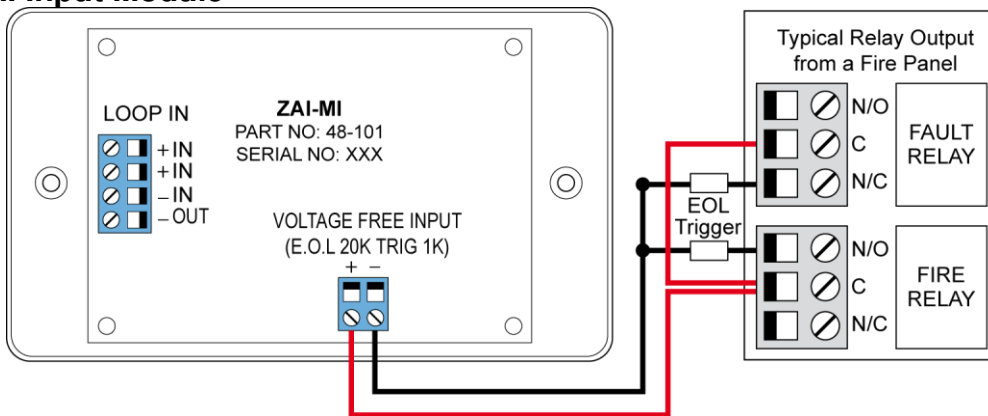

The end of line resistor value is 20KΩ and the trigger resistor value is 1 KΩ.

7.1.4 ZAIO – MI Input/output Module

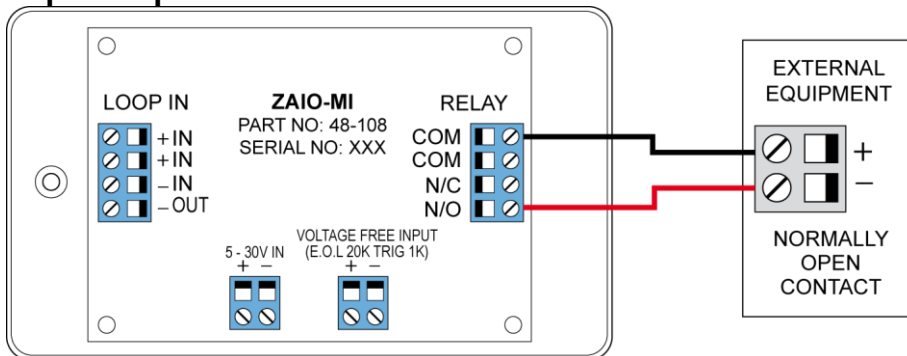

The end of line resistor value is 20KΩ and the trigger resistor value is 1K

7.1.5 ZASC – MI Sounder Control Module

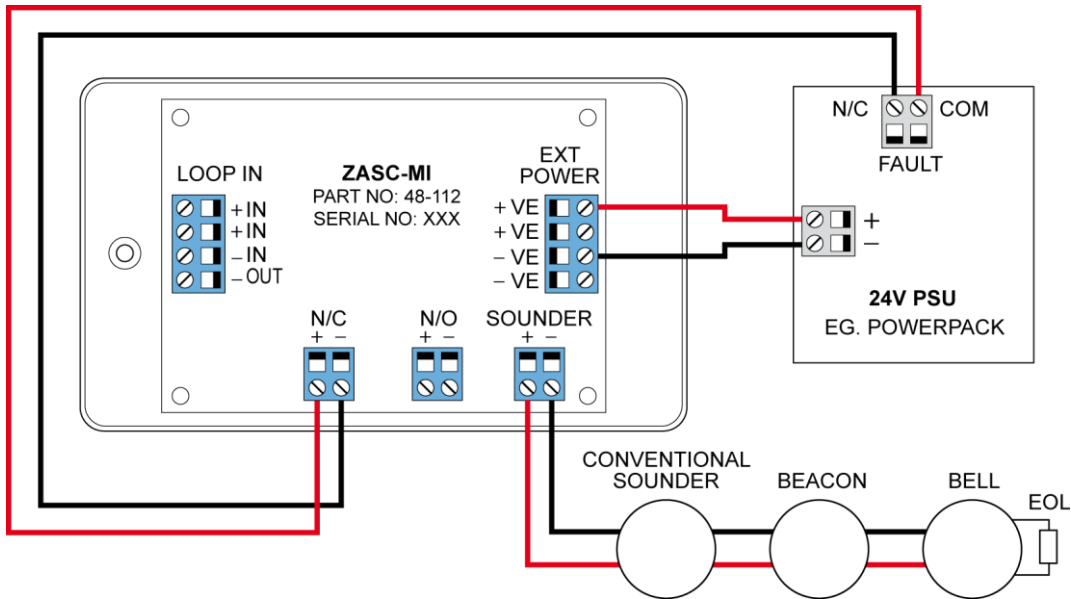

The ZASC requires an external 24vdc power supply (as shown in the above diagram). The EOL for the sounder circuit is 10KΩ. When using the ZASC make sure the PSU being used has a fault output relay, so that in the event of a power supply fault it is reported to the control panel.

Note: All Power Supplies used on fire alarm systems MUST comply with EN54 part 4

7.1.6 ZAZM – MI Conventional Zone Module

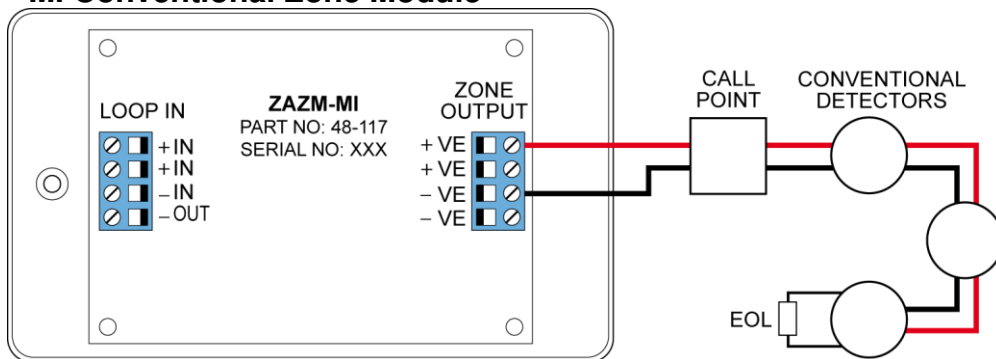

The ZAZM powers the conventional zone from the addressable systems loop, so no external power supply is required. The EOL for the zone is 6.2KΩ.

7.1.7 Xtratone Sounder/Sounder Flasher



The Xtratone sounder or sounder flasher is a wall mount sounder. The programming of the sounder is done via the D.I.L switch mounted on the inside (front). It may also be programmed via the handheld programming tool.

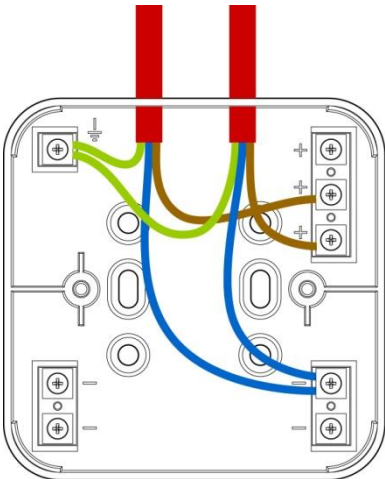

Connecting the sounder is done using the terminals in the back box of the device. Please refer to the above diagram.

7.1.8 Sandwich Sounder

The sandwich sounder has no wiring to connect as it just clips straight on to a standard base. It will run as a platform sounder using no address, it is controlled by the detector fitted to it. It can also be given an address via the handheld programming tool making it an addressable sounder.



7.1.9 Addressable Remote LED Indicator



Ceiling Mount (MKII-ARL/C)



Wall Mount (MKII-ARL/W)

There are two versions of the remote LED, Wall mounted and Ceiling mounted. The ceiling mounted version requires a standard detector base.

Each version of the remote LED can monitor 1 or up to 12 devices. The way in which the LED is programmed is either via the D.I.L switches on the device or soft addressing via the handheld programmer.

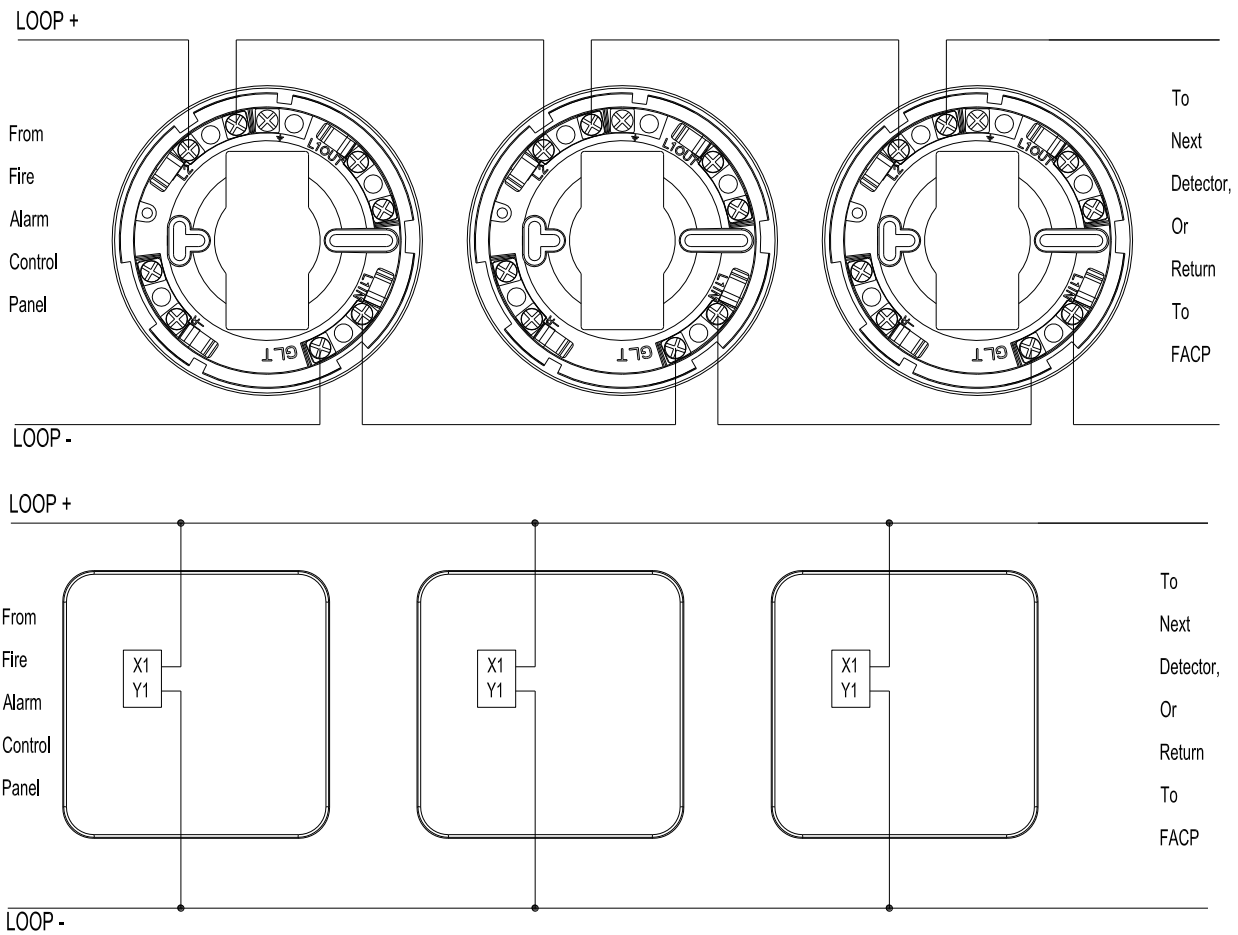

7.2 Setting the device zone & ID (detectors, call points & sounders)

The ID2 divides the loop addresses into zones and IDs. The panel translates the address into a zone and ID. Each zone starts with ID1, in order to simplify the addressing.

To assist with setting the dip switches, there is a free app available for download on the APP Store for iOS, or Google Play for Android



Search for ID2 to find the app.

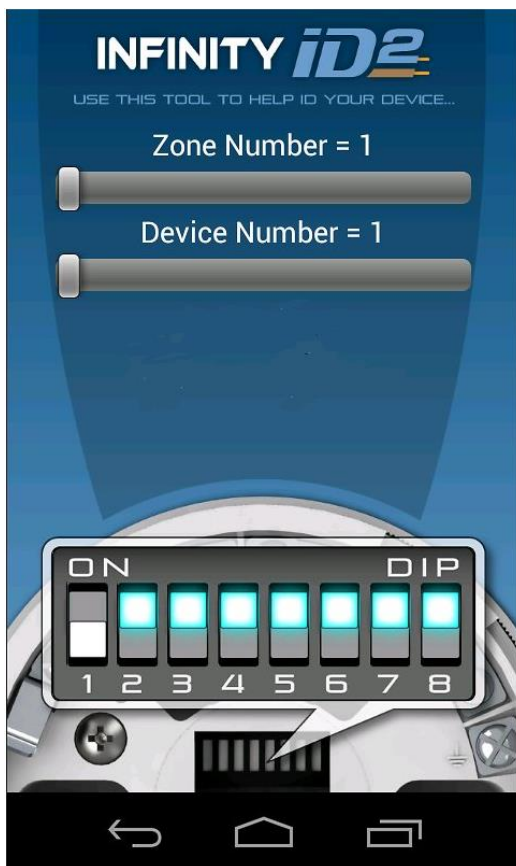

Move the zone & device ID sliders to give the switch settings for each device

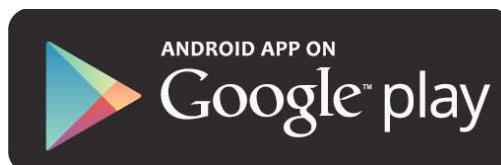
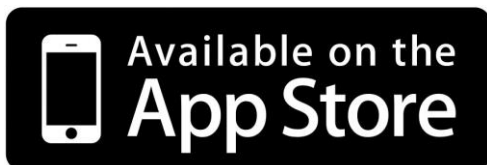

Alternatively, the table on the following page shows the switch settings.

ZONE	ID	SW1	SW2	SW3	SW4	SW5	SW6	SW7	SW8
1	1	OFF	ON	ON	ON	ON	ON	ON	ON
1	2	ON	OFF	ON	ON	ON	ON	ON	ON
1	3	OFF	OFF	ON	ON	ON	ON	ON	ON
1	4	ON	ON	OFF	ON	ON	ON	ON	ON
1	5	OFF	ON	OFF	ON	ON	ON	ON	ON
1	6	ON	OFF	OFF	ON	ON	ON	ON	ON
1	7	OFF	OFF	OFF	ON	ON	ON	ON	ON
1	8	ON	ON	ON	OFF	ON	ON	ON	ON
1	9	OFF	ON	ON	OFF	ON	ON	ON	ON
1	10	ON	OFF	ON	OFF	ON	ON	ON	ON
1	11	OFF	OFF	ON	OFF	ON	ON	ON	ON
1	12	ON	ON	OFF	OFF	ON	ON	ON	ON
1	13	OFF	ON	OFF	OFF	ON	ON	ON	ON
1	14	ON	OFF	OFF	OFF	ON	ON	ON	ON
1	15	OFF	OFF	OFF	OFF	ON	ON	ON	ON
2	1	OFF	ON	ON	ON	OFF	ON	ON	ON
2	2	ON	OFF	ON	ON	OFF	ON	ON	ON
2	3	OFF	OFF	ON	ON	OFF	ON	ON	ON
2	4	ON	ON	OFF	ON	OFF	ON	ON	ON
2	5	OFF	ON	OFF	ON	OFF	ON	ON	ON
2	6	ON	OFF	OFF	ON	OFF	ON	ON	ON
2	7	OFF	OFF	OFF	ON	OFF	ON	ON	ON
2	8	ON	ON	ON	OFF	OFF	ON	ON	ON
2	9	OFF	ON	ON	OFF	OFF	ON	ON	ON
2	10	ON	OFF	ON	OFF	OFF	ON	ON	ON
2	11	OFF	OFF	ON	OFF	OFF	ON	ON	ON
2	12	ON	ON	OFF	OFF	OFF	ON	ON	ON
2	13	OFF	ON	OFF	OFF	OFF	ON	ON	ON
2	14	ON	OFF	OFF	OFF	OFF	ON	ON	ON
2	15	OFF	OFF	OFF	OFF	OFF	ON	ON	ON
3	1	OFF	ON	ON	ON	ON	OFF	ON	ON
3	2	ON	OFF	ON	ON	ON	OFF	ON	ON
3	3	OFF	OFF	ON	ON	ON	OFF	ON	ON
3	4	ON	ON	OFF	ON	ON	OFF	ON	ON
3	5	OFF	ON	OFF	ON	ON	OFF	ON	ON
3	6	ON	OFF	OFF	ON	ON	OFF	ON	ON
3	7	OFF	OFF	OFF	ON	ON	OFF	ON	ON
3	8	ON	ON	ON	OFF	ON	OFF	ON	ON
3	9	OFF	ON	ON	OFF	ON	OFF	ON	ON
3	10	ON	OFF	ON	OFF	ON	OFF	ON	ON
3	11	OFF	OFF	ON	OFF	ON	OFF	ON	ON
3	12	ON	ON	OFF	OFF	ON	OFF	ON	ON
3	13	OFF	ON	OFF	OFF	ON	OFF	ON	ON
3	14	ON	OFF	OFF	OFF	ON	OFF	ON	ON
3	15	OFF	OFF	OFF	OFF	ON	OFF	ON	ON
4	1	OFF	ON	ON	ON	OFF	OFF	ON	ON
4	2	ON	OFF	ON	ON	OFF	OFF	ON	ON
4	3	OFF	OFF	ON	ON	OFF	OFF	ON	ON
4	4	ON	ON	OFF	ON	OFF	OFF	ON	ON
4	5	OFF	ON	OFF	ON	OFF	OFF	ON	ON
4	6	ON	OFF	OFF	ON	OFF	OFF	ON	ON
4	7	OFF	OFF	OFF	ON	OFF	OFF	ON	ON
4	8	ON	ON	ON	OFF	OFF	OFF	ON	ON
4	9	OFF	ON	ON	OFF	OFF	OFF	ON	ON
4	10	ON	OFF	ON	OFF	OFF	OFF	ON	ON
4	11	OFF	OFF	ON	OFF	OFF	OFF	ON	ON
4	12	ON	ON	OFF	OFF	OFF	OFF	ON	ON
4	13	OFF	ON	OFF	OFF	OFF	OFF	ON	ON
4	14	ON	OFF	OFF	OFF	OFF	OFF	ON	ON
4	15	OFF	OFF	OFF	OFF	OFF	OFF	ON	ON

ZONE	ID	SW1	SW2	SW3	SW4	SW5	SW6	SW7	SW8
5	1	OFF	ON	ON	ON	ON	ON	OFF	ON
5	2	ON	OFF	ON	ON	ON	ON	OFF	ON
5	3	OFF	OFF	ON	ON	ON	ON	OFF	ON
5	4	ON	ON	OFF	ON	ON	ON	OFF	ON
5	5	OFF	ON	OFF	ON	ON	ON	OFF	ON
5	6	ON	OFF	OFF	ON	ON	ON	OFF	ON
5	7	OFF	OFF	OFF	ON	ON	ON	OFF	ON
5	8	ON	ON	ON	OFF	ON	ON	OFF	ON
5	9	OFF	ON	ON	OFF	ON	ON	OFF	ON
5	10	ON	OFF	ON	OFF	ON	ON	OFF	ON
5	11	OFF	OFF	ON	OFF	ON	ON	OFF	ON
5	12	ON	ON	OFF	OFF	ON	ON	OFF	ON
5	13	OFF	ON	OFF	OFF	ON	ON	OFF	ON
5	14	ON	OFF	OFF	OFF	ON	ON	OFF	ON
5	15	OFF	OFF	OFF	OFF	ON	ON	OFF	ON
6	1	OFF	ON	ON	ON	OFF	ON	OFF	ON
6	2	ON	OFF	ON	ON	OFF	ON	OFF	ON
6	3	OFF	OFF	ON	ON	OFF	ON	OFF	ON
6	4	ON	ON	OFF	ON	OFF	ON	OFF	ON
6	5	OFF	ON	OFF	ON	OFF	ON	OFF	ON
6	6	ON	OFF	OFF	ON	OFF	ON	OFF	ON
6	7	OFF	OFF	OFF	ON	OFF	ON	OFF	ON
6	8	ON	ON	ON	OFF	OFF	ON	OFF	ON
6	9	OFF	ON	ON	OFF	OFF	ON	OFF	ON
6	10	ON	OFF	ON	OFF	OFF	ON	OFF	ON
6	11	OFF	OFF	ON	OFF	OFF	ON	OFF	ON
6	12	ON	ON	OFF	OFF	OFF	ON	OFF	ON
6	13	OFF	ON	OFF	OFF	OFF	ON	OFF	ON
6	14	ON	OFF	OFF	OFF	OFF	ON	OFF	ON
6	15	OFF	OFF	OFF	OFF	OFF	ON	OFF	ON
7	1	OFF	ON	ON	ON	ON	OFF	OFF	ON
7	2	ON	OFF	ON	ON	ON	OFF	OFF	ON
7	3	OFF	OFF	ON	ON	ON	OFF	OFF	ON
7	4	ON	ON	OFF	ON	ON	OFF	OFF	ON
7	5	OFF	ON	OFF	ON	ON	OFF	OFF	ON
7	6	ON	OFF	OFF	ON	ON	OFF	OFF	ON
7	7	OFF	OFF	OFF	ON	ON	OFF	OFF	ON
7	8	ON	ON	ON	OFF	ON	OFF	OFF	ON
7	9	OFF	ON	ON	OFF	ON	OFF	OFF	ON
7	10	ON	OFF	ON	OFF	ON	OFF	OFF	ON
7	11	OFF	OFF	ON	OFF	ON	OFF	OFF	ON
7	12	ON	ON	ON	OFF	ON	OFF	OFF	ON
7	13	OFF	ON	OFF	OFF	ON	OFF	OFF	ON
7	14	ON	OFF	OFF	OFF	ON	OFF	OFF	ON
7	15	OFF	OFF	OFF	OFF	ON	OFF	OFF	ON
8	1	OFF	ON	ON	ON	OFF	OFF	OFF	ON
8	2	ON	OFF	ON	ON	OFF	OFF	OFF	ON
8	3	OFF	OFF	ON	ON	OFF	OFF	OFF	ON
8	4	ON	ON	OFF	ON	OFF	OFF	OFF	ON
8	5	OFF	ON	OFF	ON	OFF	OFF	OFF	ON
8	6	ON	OFF	OFF	ON	OFF	OFF	OFF	ON
8	7	OFF	OFF	OFF	ON	OFF	OFF	OFF	ON
8	8	ON	ON	ON	OFF	OFF	OFF	OFF	ON
8	9	OFF	ON	ON	OFF	OFF	OFF	OFF	ON
8	10	ON	OFF	ON	OFF	OFF	OFF	OFF	ON
8	11	OFF	OFF	ON	OFF	OFF	OFF	OFF	ON
8	12	ON	ON	OFF	OFF	OFF	OFF	OFF	ON
8	13	OFF	ON	OFF	OFF	OFF	OFF	OFF	ON
8	14	ON	OFF	OFF	OFF	OFF	OFF	OFF	ON
8	15	OFF	OFF	OFF	OFF	OFF	OFF	OFF	ON

7.3 LOOP MODE - MAXIMUM LOOP LENGTH RECOMMENDATIONS

Some care must be taken when calculating the appropriate cable gauge for the system.

The main limitation is that during an alarm condition (maximum current draw), the voltage at all devices must be at least 17 Volts with at least 5V of superimposed data signal.

The exact calculation equations are beyond the scope of this manual, because of the distributed load of the sounders on the loop, but the following table gives a rough guide for maximum cable lengths at various current loads for 3 different cable gauges

Maximum Loop Current (in Alarm)	500 mA	400 mA	300 mA	200 mA
1.0mm CSA cable	500m	625m	830m	1250m
1.5mm CSA cable	750m	930m	1250m	1870m
2.5mm CSA cable	1000m	1250m	1660m	2000m

EG. A system with a maximum load of 300mA using 1.5mm cable can have a maximum loop run of 1250m end to end.

8 SOUNDERS

The ID2 has two conventional sounder circuits on board.

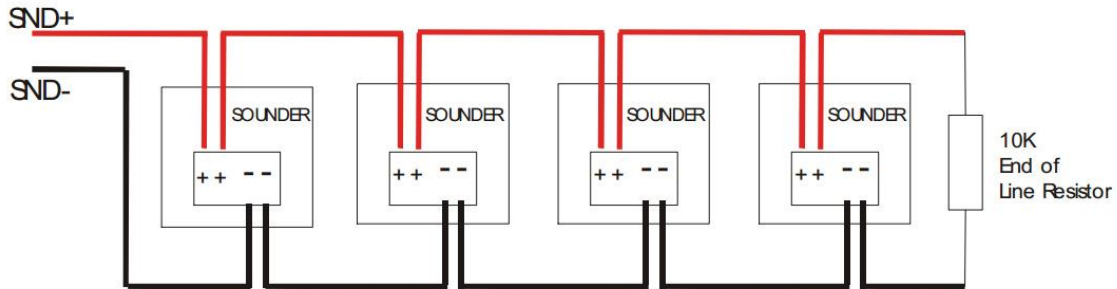

9. AUXILIARY OUTPUTS

9.1 Auxiliary output wiring

Auxiliary Fire Relay (AUX): This is a SELV volt free relay that operates in the alarm condition. It can be connected to emergency lights, local fire fighting equipment such as sprinkler systems, magnetic door holders, air conditioning shut off, etc. Extra alarm relays can be achieved by fitting extra I/O relays to the detector circuits.

Fault Output (FAULT): This is a SELV volt free relay that operates in the Fault condition. It is Normally Energised, which ensures it can give a fault signal, even in the event of total power loss.

Typical auxiliary output wiring



The Earthing of the cable screens should be as shown on the following page.

10. FIELD DEVICE TERMINATION

10.1 Terminating the wiring

Figure 6: Cable connections

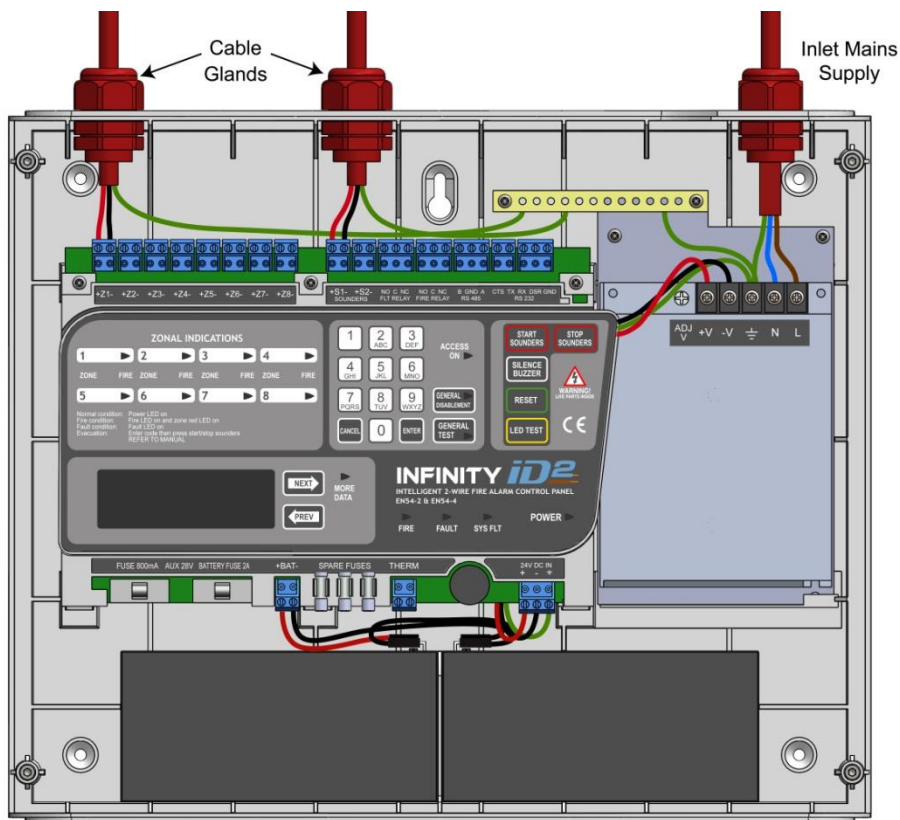

All cables entering the enclosure should have cable glands, which will prevent unwanted openings in the enclosure.

The Zone circuits should be connected to the appropriate connector block on the Termination PCB.

All cable screens should be terminated at the brass earthing strip as shown in Figure 6

11 OTHER CONNECTIONS

11.1 Repeater connection

The ID2 has an RS485 connection for a serial repeater. The repeaters have full control. Up to 2 repeaters can be powered from the Aux24V DC output on the panel. If 3 or more are to be connected, then they must be powered from external 24V power supplies. The panel supports up to 8 repeaters.

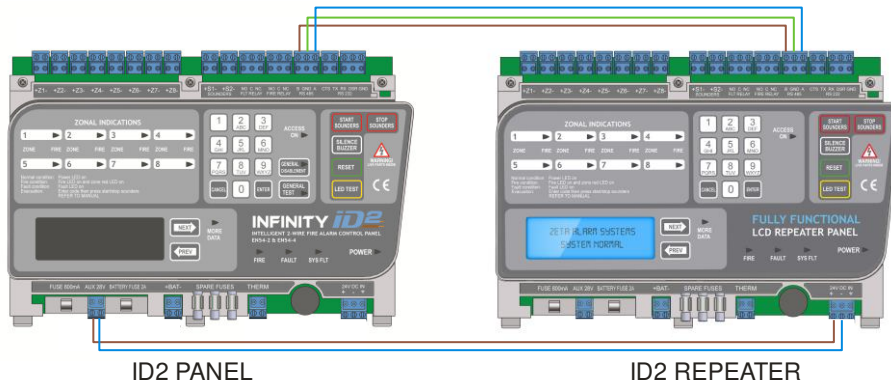

ID2 Panel	ID2 Repeater	Description
AUX 28V +	24V DC IN +	Power for repeater
AUX 28V -	24V DC IN -	Power for repeater
RS485 B	RS485 B	Data connection
RS485 A	RS485 A	Data connection
RS485 GND	RS485 GND	Data connection screen

12. CONFIGURING THE ID2 FIRE ALARM PANEL

12.1 CONFIGURING THE ZONES

12.1.1 FROM A BLANK INFINITY ID2 PANEL

1. After the system has been installed, and the cabling checked and the addresses of each device set, connect the loop cable to the CIE termination PCB (connection 1-8 as shown in Section 21.1), and power up the system (mains & batteries). The LCD should say "System Normal" and only the green Power LED will be lit. After a few seconds, the panel will find all the new devices & report them unconfigured

2. Press the enter button to configure the zones. The panel will show Configuration in progress, (while the system is configuring you have the option to enter zone labels) it will then return to the system normal screen. The zones are now configured.

12.1.2 FROM A PREVIOUSLY CONFIGURED PANEL

1. Press Enter button. This will bring up Main Menu 1 (the user menu). In this Menu there are options to set the time and date, view the status of each device, or view the event log. Press 4 to access the engineer menu

2. Press NEXT button. This will prompt for the access code to enter Engineer Menu 1 (the engineer menu). The access code for the ID2 is 369

3. The panel now shows Engineer Menu 1. In this menu there are options to View or configure the zones, to edit each device, and to configure the panel and zone text. The arrow in the bottom left hand corner shows that pressing NEXT button will take you to Engineer Menu 2

4. Press button 1 will bring up the Zone menu. Press 1 to view zone contents, or press 2 to reconfigure the zones

5. Press 2 to reconfigure the zones. The panel displays configuration in progress, Please wait. It will return to Engineer Menu 1 when completed.

12.2 Verifying the Zone configuration

1. Go to the Engineer menu 1 screen. Select option 1: Zones

2. Press button 1 to view the zone contents. The panel initially shows a summary for Each zone

To view details for each zone, press Next. The panel then lists the number of each type of device, Check that the number of devices seen compares to the number expected. If it is different, refer to the fault finding guide. (NOTE: A sandwich sounder is not seen by the panel, so is not counted.)

3. The panel is now configured, and will function as a basic system, (press Cancel until screen shows system normal to run the panel), but it is more user friendly to enter Zone labels, and/or device labels, to give a more precise location of an alarm device.

```
ID2/8 Zone
Fire Alarm Panel
System Normal
24-09-2012 09:35
```

```
Devices Found

Press ENTER to
Configure Panel
```

```
Configuration in
Progress
30%
ENTER to Label Zone
```

```
Main Menu
1:Clock 3:Device
2:Logs 4:Engineer
```

```
Enter Access Code

***
```

```
Engineer Menu 1
1:Zones
2:Panel/Zone Text
3:ID Device →
```

```
Zone Configuration
1: Zone Summary
2: Configure now
```

```
Configuration in
Progress
30%
ENTER to Label Zone
```

```
Engineer Menu 1
1:Zones
2:Panel/Zone Text
3:ID Device →
```

```
Zone Configuration
1: Zone Summary
2: Configure now
```

```
Z01: 02    Z02: 03
Z03: 00    Z04: 00
Z05: 00    Z06: 00
Z07: 00    Z08: 00
```

```
Zone 1 Contents
Smoke 01|SND 02
Heat 01|I/O 00
MCP 01|ERR 00
```

12.3 Labelling the Panel and Zones

1. To add a Zone label, go to engineer menu 1 and select option 2 Panel / Zone Text. Select option 1 to enter the panel name or customer name. Select option 2 to enter the zone text (i.e. ground floor)

```
Panel / Zone Text
1: Panel
2: Zones
```

2. Press enter when the label has been entered. Press Next to edit the next zone. (For entering a panel name, the text is entered as line 1 & line 2, so enter is pressed after each line)

```
Set Zone Name

Zone 1
Basement_
```

NOTE: For many installations, only these configuration steps are required.

12.4 Labelling the Devices

1. To add a Device label, go to engineer menu 1 and select option 3 ID DEVICE. Press enter to bring up the cursor. Type in the device label as required (0 = space, Cancel = delete. There are no cursors to edit the middle of a string)

2. Press enter when the label has been entered. Press Next to edit the next device, or Press cancel to return to normal.

```
Optical
Normal
Bedroom 30
Zone:01TD:011
```

12.5 Setting time and date

To set the time & date, enter Configuration Menu 2 and select Configure System (6). The System Menu is now displayed. Select option 1 to set time & date. Enter the Day, Month, Year, Hour & Minutes as prompted, and press enter to save, or Cancel at any time to exit.

```
Main Menu
1:Clock 3:Device
2:Logs 4:Engineer
```

12.6 Changing the alarm Tones - sounders

For most applications, the alarm tone will stay at the default setting of tone 0

To change the alarm tone, select option 5 in Engineer menu 2. You then have 3 options as shown in the window opposite. Select option 3 to change the alarm tone. There are 16 different tones that can be selected (0 – 15). Once you have selected the require tone press Enter.

```
Engineer Menu 2
4: Alarm Verify
5: Config Alarms
6: Misc
```

```
Alarm Operation
1: Relay 4: Resound
2: Interfaces
3: Alarm Tone
```

12.7 CHANGING FIRE RELAY RESPONSE

To change the fire relay response, select option 1 in the Alarm operation menu. From here you will have the following options

- Common Alarm
- Manual Alarm
- Detector Alarm

12.8 CHANGING INPUT/OUTPUT INTERFACE RESPONSE

12.8.1 DEFAULT SETTING

To change the DEFAULT interface response, select option 2 in the Alarm operation menu. From here you will have the following options

- Common
- Zonal Detector
- Zonal All
- Own Input
- Panel Link
- Manual Alarm
- Detector Alarm
- Zonal MCP

These are the Triggers that will cause the I/O's relay to operate

EG the option ZONAL DETECTOR would cause the I/O's relay to operate if there is an alarm from a Detector in its Zone.

12.8.2 SETTING INDIVIDUAL I/O UNIT OPERATION - RELAY

To alter the operation mode of an individual I/O unit, go to configuration menu 2

Select Edit Device.

Scroll to the required Address

Press button 8 (V) to cycle through the different Variations of I/O configuration

I/O Zn-D	A
Normal	
Plant Room	
Zone:01	ID:01

12.8.3 SETTING INDIVIDUAL I/O UNIT OPERATION - INPUT

To alter the INPUT mode of an individual I/O unit, go to configuration menu 2

Select Edit Device.

Scroll to the required Address

Press 6 (O) to cycle through the different Triggering Options of I/O configuration

The different options are:-

I/O Zn-D	P
Normal	
Plant Room	
Zone:01	ID:01

Letter	Description	Use
A	ALARM	I/O signals general alarm when operated. Default setting. Used when automatic & manual alarms are treated the same.
M	MANUAL CALL POINT ALARM	I/O signals a MCP alarm when operated. Used when device being monitored is Manually triggered, and the system is set to distinguish manual & automatic alarms.
P	PREALARM	I/O signals a Pre-Alarm when operated. Used when a device being monitored needs to give a warning signal , but not an alarm signal.
F	FAULT	I/O signals a Fault Signal when operated. Used when a device being monitored does not have a normally closed fault relay
D	DISABLE RELAYS	I/O sets all connected I/O relays as disabled when operated. Used when user testing of the panel needs to suspend relay operation to avoid shutting down connected equipment. Turning off the input re-enables the relays

12.8.4 I/O UNIT OPERATION - PANEL LINK

The panel link option is used as a simple alarm link between panels. When an interface is configured as a panel link, it's alarm input is non- latching. The relay will not operate if it's input signalled alarm, but will operate on any other alarm. The general set-up is to link the input of the I/O to an alarm relay on the remote panel, and then the relay of the I/O unit connects to a non latching alarm input on the remote panel.

12.8.5 CONFIGURING ALARM OUTPUT RESOUND OPERATION

Some installations require the sounders to operate in a certain way to new alarms if the sirens have been silenced. To Access the settings, go to **Engineer menu 1 / Config alarms / Resound**. The panel shows the following screen.

```
Alarm Resound
Any New Alarm

Enter to Confirm
```

Press Prev/Next to scroll between the options. The options are:-

- Resound for any new alarm
- Resound for a new zone in alarm
- Only activate for first alarm (ie don't resound)

Scroll to required option and press enter to save.

12.9 Setting the LCD language

From Engineer menu 2, Select Misc (option 6)

Then from the Misc Settings menu, select option 1 (Language)

Pressing Prev / Next will scroll through the available languages.

The panel will have one of 2 language banks:-

English
Spanish
Portuguese
French
Italian

OR

English
Hungarian
Serbian
Lithuanian

Other languages are available on request.

12.10 Software Versions

From Engineer menu 2, select Misc (option 6)

Then from the Misc Settings menu, select option 2 (Version)

The panel will display the software versions in its two Microcontrollers, one for the main functions and one for the Loop Driver. This information may be useful for technical support in the Event of any problems occurring with the Control Panel.

```
Engineer Menu 2
4: Alarm Verify
5: Config Alarms
6: Misc
```

```
Misc Settings
1: Language
2: Version
3: Topology 6: Reset
```

```
Set Language
English

Press ENTER to Save
```

```
Misc Settings
1: Language
2: Version
3: Topology 6: Reset
```

```
GLT Exports Ltd
Infinity ID2/8 Zone
Panel : 1.a. 8687
Loop : 0.k. 8680
```

(Note that the revision number is an internal reference number. It does not mean that there have been 8600+ software revisions)

13 ALARM VERIFICATION

The ID2 includes an option to use alarm verification. It is intended for use in apartments, and similar buildings, where it is desirable that an alarm from a smoke detector from one apartment (or area) would need to be confirmed before the whole system goes into alarm.

13.1 Alarm Verification Options

The current revision of the panel (Software version 1.H or later) has 2 settings for alarm verification

Device verification. With this setting, an alarm will just operate the sounder connected to that detector.

Zonal verification. With this setting, an alarm will operate sounders connected to all sounders in that zone set to Zonal verification. Zonal verification can also be set to heat detectors. But selecting this just allows the heat detectors sounder to run on a verification from another detector. An alarm on that heat detector will set the system straight into full alarm.

Advantages of Device verification	Allows for more "verification" areas per zone
Advantages of Zonal verification	Will set off all sounders for apartments with multiple detectors

Note that both types of verification can be set on a zone at the same time if required

13.1 How Alarm Verification Works

The verification function works as follows:-

1. Any SMOKE detector on the system can be set to verify an alarm. (Not that an opto-heat detector is treated as a smoke detector for verification, whether the alarm is caused by smoke or heat)
2. If a detector with the verification setting senses smoke, the detector alarm LED will turn on. If the detector has an associated sounder base, the sounder will turn on with the Alert tone (i.e. pulsed) rather than the Evacuate tone. The ID2 panel's screen will show "Confirming alarm".
3. If the device in alarm has zonal verification set, the panel will turn on the sounders of all other detectors set to zonal verification in that zone.
4. If the detector drops below the alarm level within the programmed verification time (1 minute to 3 minutes 45 seconds), the sounder will turn off, but the panel will continue displaying "Confirming Alarm" for at least 5 minutes. The buzzer will also continue to operate as long as the "Confirming Alarm" message is displayed.
5. If the detector stays in alarm by the end of the verification delay, the system will go into full alarm.
6. If another detector WITHOUT verification setting or a call point goes into alarm, the panel will go straight into full alarm.

With this method of operation a "cooking alarm" in one apartment will alarm locally, giving the apartment occupants a chance to clear the smoke before the whole building is evacuated. Also, as a "failsafe", if a heat detector alarms, or if a second smoke detector on the system goes into alarm, the system will go into full alarm.

13.2 Setting the Alarm Verification Delay

To set the verification delay, go to Configuration menu 2 and select option 6 System menu.

```

Engineer Menu 2
4: Alarm Verify
5: Config Alarms
6: Misc
    
```

From the engineer menu 2, select option 4

```

Detector Verify Time
1:30

ENTER to Confirm
    
```

From the Verification screen, select option 1 (Verify time)

Use Prev& Next to adjust the time, then press enter to confirm

13.3 Applying Alarm Verification Delay to a detector

To set the verification delay for a detector, go to Engineer menu 2 and select option 4 Alarm Verify. Then in the Verification menu select option 2 Choose Device.

```

Optical
Normal
Fl 3 Bedroom 303
Zone:01ID:011
    
```

Scroll to the required device, then press V for Verification. The letter V appears in the top right hand corner to confirm that this device has a DEVICE verification delay. Pressing "V" again will change the letter to Z for Zonal verification. Press V one more time to toggle the Verification off.

14 RESTORING THE PANELS DEFAULT SETTINGS

Because the ID2 allows several configuration changes, we have also included an option to reset the panel back to its default operation. From Engineer Menu 2, Select Option 6 (Misc).

Then from the System Menu, Select option 6 (Reset). This brings up the screen to select to reset :-

The panel can be reset as follows:-

```
Misc Settings
1: Language
2: Version
3: Topology  6: Reset
```

```
Reset Settings
1: Event Logs
2: Factory Reset
```

Option	Item	Function
1	Logs	Clears event log (Note that the Event counter is not reset) (Code 159 to reset)
2	Factory	Sets the panel back to factory default (Code 159 to reset)

NOTE: The factory reset option does not delete any panel name that has been programmed into the panel. To clear any programmed name, follow the steps in section 12.3, and use the cancel button to delete all text.

15 VIEWING PANEL INFORMATION

15.1 Menu Structure

To help locate the different features available, the menu structure of the ID2 panel is shown here.

MENU LAYOUT			
MAIN MENU	SUB MENU 1	SUB MENU 2	DESCRIPTION
CONFIGURATION MENU 1 – THE USER MENU			
1:Clock	-	-	Set the date and time
2:Logs	VIEW EVENT LOG		
	1: Alarms	-	View all fire alarm events
	2: Faults	-	View all fault events
	3: System	-	View all other events (eg User access, menu access, clock change, etc)
	4: All	-	View all events
3:Devices	-	-	View device type and zone / ID information as well as any text labels
4: Engineer	-	-	Puts the panel into Engineer menu 1
ENGINEER MENU 1 – THE ENGINEER MENU			
1:Zones	1. Zone Summary	-	View the zones and shows how many devices are fitted to each zone
	2. Configure Now		Configure the Zones
2:Panel/Zone Text	-	-	Set Panel Name and Zone Label
3:ID Device	-	-	* Edit device label (Press ENTER) * Turn on alarm LED / Flasher (Press 4) * Ring sounder(Press GENERAL TEST) * Select alarm verification(Press 8) * Configure Sandwich Sounder Base (Press 7) * Disable this device.(Press General Disable) * Configure I/O OUTPUT(Press 8) * Configure I/O INPUT (Press 6)
ENGINEER MENU 2			
4:Alarm Verify	1:Verify Time	-	Detector verify time (1:00 – 3:45)
	2:Choose Devices	-	Select the device that requires verification (this can only be set to a smoke detector)
5:Config Alarms	1:Relay	-	Edit the way the fire relay works in an alarm condition (Common, Manual, Detector)
	2:Interfaces	-	Edit the Interfaces work in an alarm condition (Common, Zonal detector, Zonal all, own input, panel link, Manual alarm, Detector alarm, Zonal MCP)
	3:Alarm Tone	-	Change the sounder output tone (there are 16 different tones)
	4.Resound		Sets whether sounder operate for any new alarm, an alarm from a new zone, or only for the first alarm. (EN54 Requirement)
6:Misc	1:Language		Select the panel language (there are 5)
	2:Version		Shows the panel and loop software version
	3:Topology		Changes the panel from Radial wiring to Loop Wiring
	6:Reset		Reset the event log and restore back to factory default settings (Requires the code 159)

15.2 Viewing device status

On the ID2, all Zone devices can be viewed from the Main Menu, or viewed & edited from Engineer Menu 1. Enter Engineer menu 1 as described above, and select option 1 (ID Device)

The following screen is shown

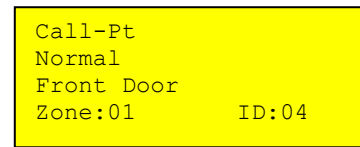

The screen is divided into the following sections:-

Configured Device Type

This shows the Device that was at this address during the last loop configuration.

The possibilities for this are:-

Optical, Ion, Heat, Call-Pt, Sounder, I/O Unit, Zone Mon, SndSmoke , SndHeat.



Device Status

This is the current status of the device. It will show one of the following values:-

Normal, Fault, Alarm or Prealarm

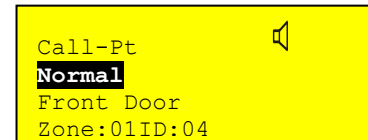

Fault Description

If the device is in a fault condition, a description of the fault will appear here. It will show one of the following messages:-

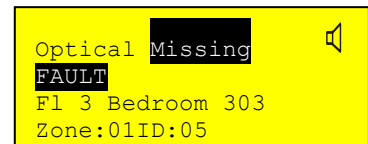

FAULT	MEANING
Changed	The device had been changed with one of a different type since last configuration. The message will flash between Changed, and the new type of device seen (eg. Heat).
Missing	The device is not communicating (ie removed , damaged or Address setting changed)
DetRmvd	A Detector has been removed (from an ID2 Base only)
Side A Only	There is a break in the cable, and the device is only seen from Side A – Loop Mode Only
Side B Only	There is a break in the cable, and the device is only seen from Side B – Loop Mode Only
2-ADDR	Two devices have the same ID switch setting
No message	This device is signalling an internal fault by returning a value of less than 8.

Device Label

This is the 20 character description of the device location entered by the installer. To change this Press Enter button to activate the cursor.



Device Identification

This is the Zone and address of the device. This is how the device will probably be referred to on the system drawings.



15.3 Locating a device

From the ID device screen, it is possible to send commands to individual devices to start their sounder, or to turn on their alarm LED / Flasher.

Select the Zone and ID for the device to be checked.

If the device has an LED,, its LED can be turned on by pressing Button 4. A star will appear in the top right hand corner to show that the LED has been lit on this device. Press again to turn off.

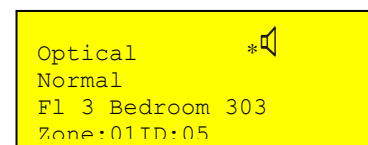

If the device is a sounder or I/O with a relay, the sounder or relay can be started by pressing the GENERAL TEST button. The Outline sounder Symbol turns solid to show that the Sounder is active. Press again to turn off. Similarly their Flasher can be started by pressing button 4. Press 4 again to turn off.

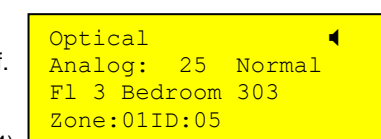

The sounder and flasher can both be activated if required. (Press General test, then 4)

Scrolling to another device or exiting the menu will automatically turn the LED or sounder/flasher off.

15.4 Using the event log

The ID2 has a 1000 entry event log. In the event of the log being full, it will wrap around, and overwrite the earliest entries. The event log can be viewed through Configuration Menu 1 by selecting Option 3 - View Event Log. The screen prompts for which events to display: Alarms, Faults, System or All.

```
View Event Log
1: Alarms    4: All
2: Faults
3: System
```

Alarms

If the alarm option is shown, only alarms will be displayed. The screen will show the event number, the date, the time, the type of event (in this case, a DEVICE ALARM), and the Zone, and address. Next & Previous buttons will cycle through the list.

```
Event 167
13-01-2007 17:21
Device Alarm
Zone:03    ID:010
```

Faults

Selecting this option will display all the faults recorded on the system, Both device faults and general faults. The screen will show the event number, the date, the time, the type of event (in this case, a DEVICE CHANGED fault), and the Zone, and address, if appropriate. Next & Previous buttons will cycle through the list.

```
Event 173
25-01-2007 17:21
Device Changed
Zone:01    ID:013
```

System.

The ID2 also records other non critical items, such as User access, clock change, configuration changed, event log erased etc. These can be used to help determine the chain of actions before or after an event. The types of events recorded are: - Power On/Startup, Panel Reset, Evacuate, Access Level 2, Access Level 1, Sounders Silenced, Configure Loops, Time & Date Set, Zone Disabled, Zone Enabled, Device Disabled, Device Enabled, Zone Test Start, and Zone Test Finish.

```
Event 174
25-01-2007 17:22
Access Level 2
```

Note: during installation and commissioning, it is possible to create a large number of events, especially if a configured Zone is disconnected. This is normal, and is not a case for concern. These events can be cleared, using Engineer Menu 2.

```
Reset Settings
1: Logs
2: Zones
```

To clear the event log, go to Engineer Menu 2 and select option 6 (Configure System). Select Option 6 to go to the reset screen. Choose option 1 to reset event log.

```
Clear Event Log

ENTER to Continue
```

The screen warns that this cannot be undone. Press ENTER to clear the event log, or any other button to cancel this screen. It will also prompt for the access code (159)

```
Clear Event Log
WARNING: This Action
cannot be undone
ENTER to Continue
```

Note that when the event log is cleared, the EVENT NUMBER remains the same. This is so that a visiting engineer will have an idea of the activity on a panel, even if the event log has been cleared. The counter has a maximum value of 524287, and will return to 0 after this.

```
Enter Access Code
```

16. THE FIRE ALARM CONDITION

16.1 Viewing a fire alarm event

The way the ID2 panel shows fire alarm information has been changed slightly from previous versions of the panel. The LCD screen text has been altered to show the first & last zone entering the alarm condition.

For Example, a first alarm on a system will bring up the display:

```
FIRE           First Z01
1 of 1
Managers Office
Z1 ID:001
```

This Means there is a fire alarm condition. It is the first (and only) alarm that has Occurred (Fire 1 of 1) The device signalling alarm is in the Manager's office, and It is address 001 in zone 01.

If a second fire then occurs in say zone 2, the system would display:

```
FIRE           First Z01
1 of 2         Last Z02
Managers Office
Z1 ID:001
```

The bottom 2 lines will still show the details of the first alarm (Press Prev or Next to Display information about the second alarm). The top right hand corner shows the first zone that gone into alarm, and the last NEW zone that has gone into alarm. Note that the numbers in the top left corner (1 of 2) is the number of DEVICES in alarm, not the number of zones in alarm. The ZONAL LEDS will indicate the number of zones in the alarm condition.

```
FIRE           First Z01
2 of 2         Last Z02
Kitchen
Z2 ID:017
```

So for example, if there was a third alarm, this time from zone 1 again, the right hand corner would continue to show First alarm ZONE 1, Last alarm ZONE 2. This allows the fire brigade to see the spread of the fire.

```
FIRE           First Z01
1 of 3         Last Z02
Managers Office
Z1 ID:001
```

Because of this, if there are multiple alarms, they are grouped by zone, so scrolling to review alarms would show all alarms in the first zone in alarm , then all alarms in the second zone that went into alarm etc. To view the alarms chronologically, the event log must be used.

16.2 Viewing Faults during a fire alarm condition

In the event of multiple alarms, and multiple faults on the system at the same time, the LCD screen will give priority to alarm events. The screen will show the first alarm, and the Prev/Next scroll buttons will cycle through alarm events only.

The LEDs will show general fault information. To show fault event details on the LCD screen, press the CANCEL button. Prev& next will now scroll through the faults. Press cancel to return to viewing the fire alarm information. (If the panel is left viewing a fault, after a short period of inactivity, the panel will revert to the fire alarm display)

A sounder fault is classed as an Indication that should not be suppressed, to the panel reserved part of the bottom line of the LCD to indicate sounder faults.

```
FIRE           First Z01
1 of 1
Managers Office
Z1 ID:001      ▲
Fault
```

16.3 Viewing Zone Disablements during a fire alarm condition

If no individual devices are disabled, then by pressing the GENERAL DISABLEMENT button and the disablement SELECT button, information about zone disablements and the number of individually disabled devices per zone can also be viewed on the LCD.

If one or more devices are disabled, then when the GENERAL DISABLEMENT button is pressed, the screen will display the options as shown. Press 1 to select zone disablements, and then continue as per the paragraph above.

```
Disablement
1: Zones
2: Devices
```

16.4 Viewing Device Disablements during a fire alarm condition

To view individual device disablements during an alarm condition, press the GENERAL DISABLEMENTS button, and the screen will display the options as shown above. Press 2 to select device disablements, and press the Next button to scroll through all the disabled devices. A sounder disablement isn't suppressed, so is shown on the LCD.

```
FIRE           First Z01
1 of 1
Managers Office
Z1 ID:001      🔔 Disable
```

16.5 Viewing Zones in Test Mode during a fire alarm condition

To view details of a zone in test during a general alarm (caused by an alarm from a zone not in test), Press the general test button. The panel will display details of the zone in test. The panel will time out to display the general alarm screen within 20 seconds of the last button press.

17. DISABLEMENT

On the ID2, there are 2 disablement options. A whole zone of devices can be disabled, or an individual device in a zone can be disabled. Both types of disablement can be used at the same time if required.

Note that when there is any type of disablement present, line 3 of the “System Normal” screen will show “Disablements Present”.

```

ID2
FIRE ALARM PANEL
Disablements Present
27-09-2010 15:16

```

Also note that any required disablement(s) must be programmed before a zone is put in to test mode.

17.1 Zone disablement

To aid commissioning and assist routine maintenance checks, any of the zones or the loop sounders can be disabled.

When a zone is disabled, the panel will not respond to any fault or fire signals it receives from any device in that zone.

This might be used if the system requires routine maintenance, and the customer needs the system to continue running, but doesn't want spurious false alarms.

The panel will respond in the usual manner to any events in any non-disabled zones.

The ID2 also allows the sounders to be disabled. If they are disabled, the panel will not start any sounders in an alarm condition.

17.2 To programme zone (or sounders) as disabled

Any number of zones (or the sounders) can be disabled, but it is good practice to only disable one zone at a time.

1. Enter access code (123)
2. Press GENERAL DISABLEMENT button and the screen will first prompt for a code(248): The screen will then show ZONE DISABLEMENT ZONE 1. The panel is now in SELECT DISABLEMENT MODE.

```

Zone Disablement
Zone 1
Zone Enabled
Disabled Devices: 0

```
3. Press NEXT key until the required zone or sounders are DISPLAYED. Press ENTER button. The screen will now show that the zone is disabled, and the Zone or Sounder LED will come on steady, along with the GENERAL DISABLEMENT LED. This section is now disabled. **(NOTE: Call points in this zone will also be disabled. To keep the call points functioning, disable the detectors in that zone individually as devices – see 17.3)**

```

Zone Disablement
Zone 3
Zone Disabled
Disabled Devices: 0

```
4. If more than one zone (or sounder) needs to be disabled, then press NEXT key again until the required zone (or sounder) is selected.
5. If the panel needs to be taken out of SELECT DISABLEMENT MODE (eg to silence a fault on another part of the system), press ENTER button.
6. Once all the maintenance work has been done the zones need to be enabled again. If the panel is still in SELECT DISABLEMENT MODE, jump to paragraph 7, otherwise, press GENERAL DISABLEMENT button (enter access code if requested). The panel is now in SELECT DISABLEMENT MODE
7. Press the NEXT button until the disabled zone is displayed on the screen. Press ENTER button to de-select disablement. Scroll to any other disabled zone and enable in the same way. When all zones are enabled again, the GENERAL DISABLEMENT LED will turn off. (NOTE: This will also enable any points individually disabled in that zone)

17.3 Device disablement

The ID2 panel can also disable individual devices (detector, call point, sounder or interface). To do this, enter ENGINEER MENU 1 and select ID DEVICE. Select the required device, then press GENERAL DISABLEMENT button. The Device label now flashes between the programmed label and Device Disabled. The general disablement LED will also be lit. This device is now disabled. To re-enable the device, press the disable button again.

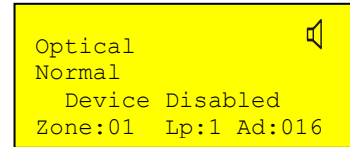

17.4 Viewing disablements

When disablements have been programmed (either zone or device), the general disablement LED will be lit. To view the disablements, press the GENERAL DISABLEMENTS button, and the screen will show the following:

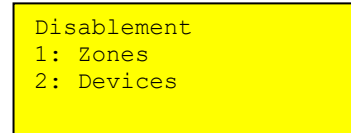

17.4.1 VIEWING DISABLED ZONES

To view which zones are disabled, press 1 and then scroll through all the zones, by pressing the Next button

If a zone is not disabled, the screen will show

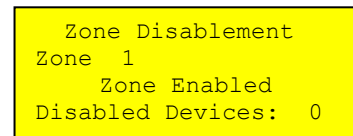

If a zone is disabled, the screen will show

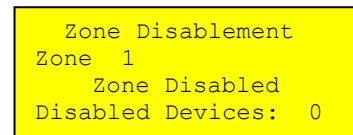

If there are one or more disabled devices in a zone, the screen will show this by the number of Single Devices as follow.

(TIP: a quick way to enable several disabled devices is to disable the zone in which these devices are located, then re-enable it)

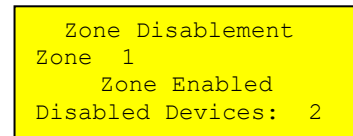

17.4.2 VIEWING DISABLED DEVICES

To view which devices are disabled, press 2 and scroll through all the disabled devices, by pressing the Next button.

The screen will show:

Line 3 will flash between the device label and Device Disabled Message.

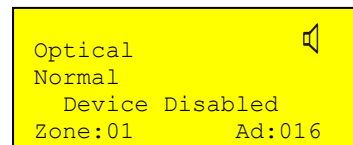

18. TEST MODE

18.1 Why use test mode

To aid commissioning and assist routine maintenance check, a silent, non-latching 'one man test' facility is available.

When a detector or manual call point is triggered on any zone in Test, the Device will light it's LED, When the smoke has cleared, or the call point has been reset, the LED will turn out.

Should an Alarm occur on a zone that is not programmed to test, the Fire Alarm Panel will go into full alarm. The Zone test LED will continue to be lit. When the alarm has been reset, test mode will resume

18.2 To programme zone in test mode

NOTE: Only **one zone** can be programmed in test at any one time.

1. Enter the user password 123;
 2. Press TEST Button. The screen will prompt for the test code
 3. Enter the Test code **2 4 8**.
 4. The screen will now invite you to select the zone to be tested, as follows:
- Enter Access Code

█
- Select Zone to Test
Zone 1

Normal Operation
5. Press TEST FUNCTION SELECT button to select the zone to be tested.
 6. Press CONFIRM to enter test mode for this zone
The General Test and Zone Test LEDs will now be lit.
 7. Detectors in this zone can now be tested with smoke spray. The Detector will light it's LED until the smoke clears, then it will reset. The Sounders & the fire relay are not operated during test mode.
 8. Once testing of that zone is completed, press TEST FUNCTION SELECT button to move to another Zone or Press CANCEL to exit test mode.

Select Zone to Test
Zone 1
Test Active
Zone 1

18.3 To program sounder circuits in test mode

1. Enter Access Code (123)
2. Press General TEST Button, The screen will prompt for the test code.
Enter the code 2 4 8.
3. The screen will now show Test Mode, Zone 1, Normal Operation.
4. Press NEXT button several times to select the Required SOUNDERS. (External sounder circuit 1, 2, or Line (Zone) sounders
5. Press ENTER test mode for this function. The general test LED will now be lit.
6. The Sounders will now pulse 8 seconds on, 8 seconds off until they are taken out of test mode. This allows all the sounders to be tested for correct operation, and dB output.
7. Once testing of the sounder circuit is completed press CANCEL exit test mode.

Enter Access Code

█

Select Zone to Test
Zone 1

Normal Operation

Select Zone to Test
Line Sounders
Test Active
Line Sounders

19. GENERAL FAULT FINDING

On the ID2 panel, Faults are divided into 2 types, "Faults" and "Device Faults". Device Faults are any fault associated with a particular Device on the system. Faults are everything else, EG, power supply etc. In the event of multiple faults, the Faults are grouped together first, followed by the device faults. Next button will scroll to next fault.

19.1 Common fault

This is a general indicator which lights whenever a fault is present. It doesn't refer to a specific fault.

19.2 Zone contents fault finding

If the Zone contents are different to what was expected, then the probable causes are:-

1. Two or more devices may have the same address setting. This is referred to as a double address fault. If this occurs all devices with the same address will answer at the same time. The panel will not be able to understand the answer it receives. **NOTE: If a panel detects a double address, it will light the LEDs of the devices with the problem. (NOTE: only detectors will light their LED. Sounders & interface modules will not be indicated).**
2. There may be some reversed connections to devices (they are polarity sensitive). The Fyreye detectors should be connected Zone + to L2, Zone - to L1IN. Other devices will have their polarity marked by their connections.

If the panel reports any double addresses present, investigate these first as they are the easiest to find. The panel will turn on the LED of any incorrectly addressed detector. (See 19.6 DOUBLE ADDRESS)

If there are still less devices than expected, check the missing addresses for correct wiring polarity. If in doubt, contact your supplier.

If the wiring polarity is correct, check that there is no cable break on the loop. (If there is a break, the panel will report the break after 60 seconds or so, and the break can be verified by measuring one side of the loop with a DVM. The loop will be on for approx 20 sec, and then will power just one side for 5 sec, then power both for 20 sec, then power just the other side for 5 seconds. (So the voltage should be monitored for approx 50 sec for a full cycle to confirm a cable break)

Some devices take a few seconds to power up, so may show as missing during the repeated Power Down / Power Up cycle that occurs during a line break.

19.3 Zone faults

There are several reasons for the fault LED to light.

1. A device has the wrong configuration setting for the zone it is fitted to. (see section 7.3 Setting the device ID)
2. There is a cable break, or short circuit to devices in that zone,
3. A device has been removed from that zone
4. A device has been changed for one of a different type
5. There is a double address in this zone (see previous section)
6. A device in that zone is communicating a fault condition to the panel.

The LCD will show Device Fault, the user label, and the address of the fault. Pressing enter will bring up the View Device screen for the device showing fault. This will give more information about the fault.

```
*** Device Fault ***
      1 of 1
Floor 1 Room 101
Zone:01      Ad:001
```

In this example, the detector is removed. IE the sounder base cannot see the Detector.

This could either be a removed detector, A detector that is not correctly seated in its base or an incompatible detector has been fitted.

Check the device has not been removed

Check that there is power to the base. Check Device ID switch hasn't been changed (compare to system set-up chart). Check that the base contacts are clean and free from dirt & corrosion. Try a replacement detector head.

```
Optical Missing
Fault
Zone:01      Ad:001
```

19.4 Supply faults

FAULT MESSAGE	Caused by	Remedy
BATTERY FAULT	Loss of Battery power	Check battery fuse is intact. Check that battery connections are secure
POWER SUPPLY FAULT	Loss of Mains power	Check that main power is present. Check that PSU cage has output healthy LED on Check cables from PSU cage to PCB are fitted securely Check Power in fuse is intact.
LOW BATTERY FAULT	Low Battery voltage detected	Check battery voltage. (should be 26-27V) Check that 2 x 12v batteries are connected in SERIES) to give 24V If there has been a recent mains failure, leave the batteries charge for an hour or so to see if the fault clears.
CHARGER FAULT	Failure of Charging circuit	Remove all power. Wait for 10 seconds then reconnect power. If fault returns, the charger circuit has been damaged, and the PCB will need to be repaired or replaced.
BATTERY HIGH IMPEDANCE	Bad Batteries Detected	Check that the correct rating battery fuse is used, and that it is fitted securely (Other fuse ratings can sometimes cause a bad reading) Check Batteries with a load test meter to confirm the batteries are bad, and replace if necessary. Check battery terminals are clean, and make a good contact with the battery leads.

19.5 Earth faults

An EARTH fault indicates that something is shorting to earth (usually through the cable screen). Disconnect the earth screens one at a time to determine the problem line.

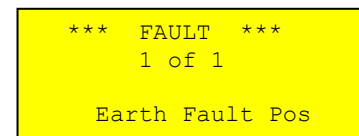

(Note: connecting other equipment, eg an oscilloscope or a PC, to the panel can give an earth fault)

The Screen will indicate if it is a Positive or Negative voltage shorting to earth (Earth Fault Pos or Earth Fault Neg).

*****DO NOT DISCONNECT THE MAINS EARTH CONNECTION. THIS WILL CAUSE A PROBLEM WITH THE PANELS OPERATION*****

19.6 Double address

This indicates that a double address has been detected. This usually happens during initial setup, where 2 detectors are given the same address, or if a head is replaced during maintenance and its address has been wrongly set. In the second scenario, the panel will report 2 fault addresses, one will be the double address, and the other will be a missing device. As a further aid to finding the fault, the panel will light the LEDs of any detectors with a double address (Sounders & I/O units will not be indicated as they have no panel controlled LED to light up)

1. Make a list of the double addresses reported (there may be more than one).
2. Go to view device screen in Configuration menu 1. Scroll through the devices, and make a list of any that are missing (**Note**: the panel skips over empty addresses when scrolling)
3. Go to the location of the missing device, and check if it has its LED on (Detector), or check the dip switch setting.
4. If this does not cure all double addresses, go to the known location, and temporarily remove the device. The panel will now report the type of device that was also configured to this address from the view device screen. This will help narrow down the search for the device. (eg if extra device is call point, check the address settings of all the call points)

19.7 System fault

A system fault is an abnormal microprocessor running condition due to various unexpected phenomena.

This will result in the panel attempting to correct itself. Should this fault occur, the System Fault LED, General Fault LED, General Fault relay and fault internal buzzer will be constantly active until the control panel is reset. This should cause the system fault condition to clear. If not, consult your supplier.

20. STANDBY BATTERY REQUIREMENTS

20.1 Standby battery calculation

In order to calculate the standby battery size required, the following formula can be used:-

$$\text{Battery Size (Standby time in Amp Hours)} = 1.25 \times [(Df \times T_{ALM} \times I_{ALM}) + (T_{SBY} \times I_Q)]$$

(DF is a derating factor (typically = 2) used when a battery has to supply a high current load)

Where:

- T_{ALM} = Maximum time in hours required for the alarm [$\frac{1}{2}$ hour is most common time]
- I_{ALM} = Total Alarm Current in amps for all alarm devices connected to the alarm circuits
- T_{SBY} = Standby time in hours for the system after mains failure [normally 24, 48 or 72 hr]
- I_{QP} = Quiescent current in amps of control panel in fault condition [because of mains failure]
- I_{QZ} = Quiescent current in amps of all detection zones.

20.2 Device Values for Battery calculation

Device	Quiescent	Alarm	Comment
ID2 Panel	50mA	102mA	This is the current used during mains failure
ID2 Repeater	50mA	75mA	
Fyreye MKII Addressable Optical Smoke Detector	0.5mA	5 mA	
Fyreye MKII Addressable Heat Detector	0.5 mA	5 mA	
Fyreye MKII Fixed Temperature Heat Detector	0.5 mA	5 mA	
Fyreye MKII Addressable Opto-Heat Detector	0.5 mA	5 mA	
Zeta Addressable Manual Call Point	0.6 mA	2.5 mA	
Zeta Addressable Weatherproof Manual Call Point	0.6 mA	2.5 mA	
Fyreye MKII Addressable Xtratone Sounder	0.6 mA	4.5 mA	
Fyreye MKII Addressable Xtratone Sounder Flasher	0.65 mA	7.4 mA	
Fyreye MKII Addressable Xtratone Flasher	0.6 mA	5.5 mA	
Sandwich Sounder Base	0.6 mA	4 mA	
Sandwich Sounder Flasher Base	0.65 mA	7.5 mA	
Zeta Fyreye MKII Input Unit	1.0 mA	3.6 mA	
Zeta Fyreye MKII Input Output Unit	1.0 mA	3.6 mA	
Zeta Fyreye MKII Input Output Unit – mains switching	1.3 mA	2.9 mA	
Zeta Fyreye MKII Sounder Control Module	0.6 mA	0.8 mA	
Zone Fyreye MKII Zone Monitor Unit	3.5 mA	19 mA	

20.3 Example battery calculation

A system comprises of a 4 zone Infinity ID2 panel, with 10 sounder-flasher bases, 1 call point, 1 Wall sounder flasher (xtratone), and one I/O per zone and the required standby is 24 hours. It will need to operate in alarm for ½ hour.

Calculate the battery size required.

$$T_{ALM} = 0.5 \text{ Hr}$$

$$T_{SBY} = 24 \text{ Hr}$$

$$I_{QP} = 0.050\text{A (Quiescent current for panel)}$$

$$I_{QD} = 4 \times ((10 \times 0.9) + 0.6 + 0.65 + 1.0) / 1000 = 4 \times 11.25 / 1000 = 0.045 \text{ A}$$

$$I_{AP} = 0.102\text{A}$$

$$I_{AD} = 4 \times ((10 \times 7.2) + 2.5 + 7.3 + 2.0) / 1000 = 4 \times 83.8 / 1000 = 0.3352 \text{ A}$$

Therefore using the equation:

$$\text{Battery Size (Standby time in Amp Hours)} = 1.25 \times [(Df \times T_{ALM} \times (I_{AP} + I_{AD})) + (T_{SBY} \times (I_{QP} + I_{QD}))]$$

$$\text{Battery Size (Standby time in Amp Hours)} = 1.25 \times [(2 \times 0.5 \times (0.102 + 0.3352)) + (24 \times (0.050 + 0.045))]$$

$$\text{Battery Size (Standby time in Amp Hours)} = 1.25 \times [0.4372 + 2.28]$$

$$\text{Battery Size (Standby time in Amp Hours)} = 1.25 \times 2.7172$$

$$\text{Battery Size (Standby time in Amp Hours)} = 3.3965 \text{ Amp Hours}$$

This system would require a minimum of 3.3965 Ah batteries, so we would recommend using 3.4Ah batteries (as the enclosure is designed for this size battery).

21. PCB TERMINATION CONNECTIONS.

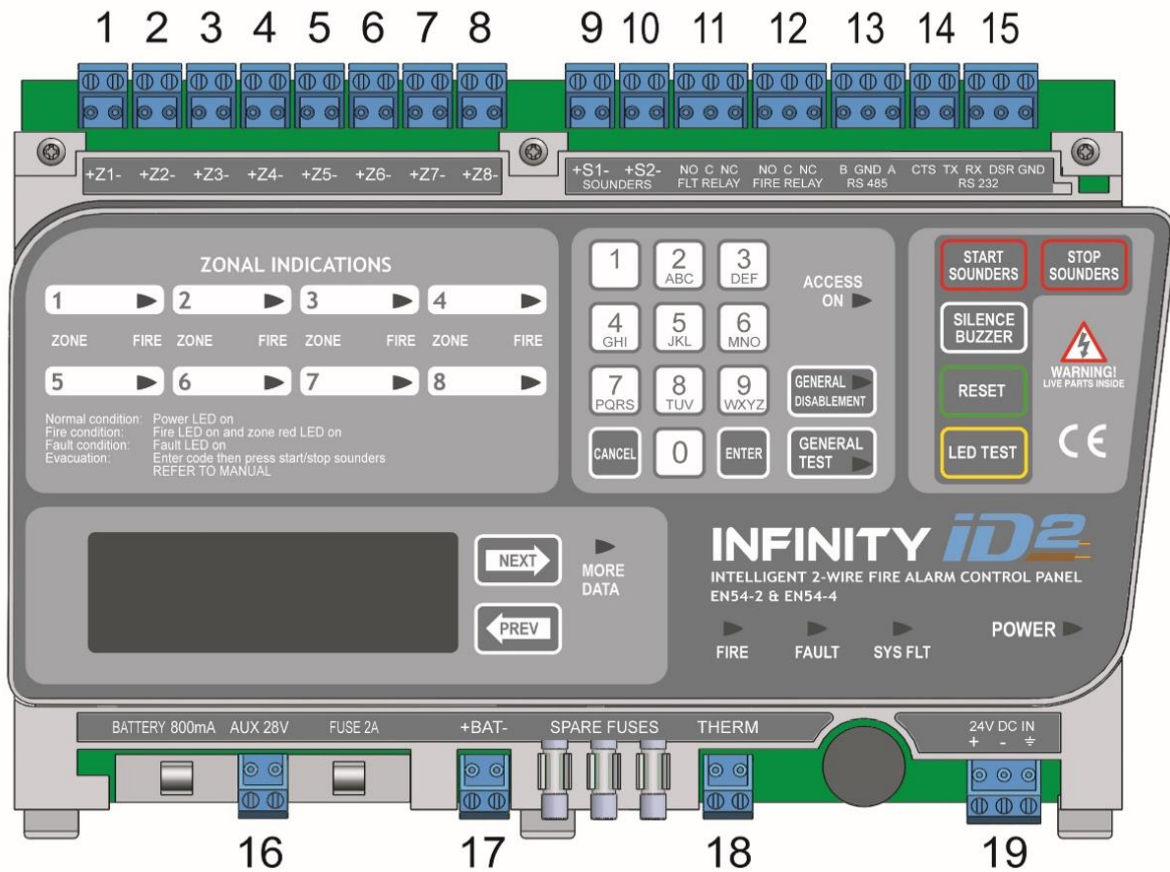

Connection No	Description	Use
1- 8	Zone 1- 8	Connection for zone wiring
9	Sounder circuit 1	Connection of conventional sounders
10	Sounder circuit 2	Connection of conventional sounders
11	Fault Relay	Volt free relay. normally energised. Operates on any fault
12	Fire Relay	Volt free relay – Operates on a fire condition
13	RS485	Connection for Repeater panel
14 & 15	RS232	NOT ACTIVE
16	Aux Power Supply	Power External Equipment, such as a repeater panel.
17	Battery Connections	Connects batteries to the PCB
18	Thermistor	Monitors battery temperature
19	24VDC Input	Connection from power supply

Fuse Ratings

PCB DESCRIPTION	VALUE
Power In Fuse	T2AL 250V
Battery Fuse	T800mAL 250V



22 SPECIFICATIONS

22.1 Enclosure specifications

DESCRIPTION	VALUE
ENCLOSURE SIZE	369 x 310 x 113 mm
TOP CABLE ENTRIES	15 x 19mm DIA ENTRIES

22.2 Electrical specifications

ELECTRICAL DESCRIPTION	MINIMUM	NOMINAL	MAXIMUM
MAINS VOLTAGE	-15%	230VAC @50/60Hz	+10%
BATTERY VOLTAGE		24V DC (2 x 12V SLA)	
BATTERY SIZE	3.4Ah		7Ah
POWER SUPPLY TYPE		Non-Integral (Switch Mode)	
SWITCHING FREQUENCY		100kHz	
SYSTEM VOLTAGE	19.5V (+/-1V)	29.5V	30V (+/-1V)
PSU CAGE OUTPUT			85 W
IMAX A (AT C.I.E. OUTPUT)			205 mA
IMAX B (AT C.I.E. OUTPUT)			900 mA
IMIN (AT C.I.E. OUTPUT)	0.4 mA		
OUTPUT VOLTAGE RIPPLE			700mV
MAX CURRENT DRAW BY PSE			2mA
MAX BATTERY INTERNAL RESISTANCE RIMAX			1.5 Ω
CHARGER VOLTAGE		27.6V @ 22-24°C	
CHARGER CURRENT			300 mA
BATTERY DEEP DISCHARGE PROTECTION		Batteries < 21V DC	
ZONE VOLTAGE	19.5 (+/-1V)	28V DC (+9V data)	30V (+/-1V)
TOTAL ZONES RATING			500mA Max (in Radial or loop mode)
NUMBER OF RADIAL CIRCUITS	1		8
NUMBER OF LOOPS			1
NUMBER OF ZONES			8
MAXIMUM DEVICES PER ZONE			15
SOUNDER ALARM OUTPUTS	2x 150mA @ 19.5V DC (+/-1V)	2x 150mA @ 28V DC	2x 150mA @ 30V DC (+/-1V)
MAXIMUM LOOP SOUNDER QUANTITY			80 SOUNDERS
ALARM RELAY OUTPUT			1 x Volt Free Relay SELV, 1A Max
FAULT RELAY OUTPUT			1 x Volt Free Relay SELV, 1A Max (Normally Energised)
AUX POWER OUTPUT	19.5V (+/-1V)	28V Nominal	30V (+/-1V)
AUX POWER RATING			100mA
REPEATER CONNECTION		RS485	

 2797	 0086
<p>Zeta Alarms Limited, 72-78 Morfa Road, Swansea SA1 2EN</p> <p>16 23</p> <p>CPR Certificate: 2797-CPR-670814 UKCA Certificate: 0086-CPR-780432</p>	
<p>EN54-2:1997+A1:2002 + A2: 2006 EN54-4:1997+A1:2002 + A2: 2006</p> <p>Control and indicating equipment for fire detection and fire alarm systems for buildings</p> <p>Infinity ID2 Addressable Fire Panel</p> <p>ID2/2, ID2/4, ID2/8</p> <p>Provided options:</p> <p>Output to fire alarm devices Dependancies on more than one alarm signal Fault signals from points Disablement of addressable points Test Condition</p> <p>Other Technical Data: See Doc: "Infinity ID2 Product file" held by the manufacturer</p>	

Installation Manual Modification History

ISSUE	DATE	CHANGES
1.0	22/1/2013	Initial Release (Section 16.5 coloured white (“deleted”) – waiting software update)
1.1	23/3/2013	Corrected enclosure dimensions // Added max loop length // Added SndSmoke and SndHeat to device list // Added I/O Panel Link Information // Updated software version in header Re-write section 16.5 (viewing test mode during alarm) Deleted “Do not print...” from mod history page. This page will now be included as part of the manual Added note that factory reset does not clear name. It must be manually deleted.
1.2	11/7/2013	Corrected Typos:- Page 17. 11.1: 2 nd line of table reads “AUX 28V 1” should read “AUX 28V +” Page 32. 19.7: resetting from a system fault by use of the keyswitch. ID2 does not have a keyswitch. Page 35. 22.2: In table: “ Battery deep discharge protection batteries less than ” should read “batteries less than 21V” Deleted repeated “to teach” in Using this manual section Added missing “HOLD” in handling PCB section Corrected charge current from 150 to 350mA Correct AUX power use in termination connections table. Reworded :- Changed "add ZIOU to loop" to "add I/O relay to detector circuits" Reworded Topology description in menu structure table Amended device fault description in general fault finding section Deleted "loop on LED reference" in fault finding section - applies only to simplicity. Updated:- Changed BS5839 -1 references to 2013 version (4 occurrences) Added loop wiring terminal information. Added info to Electrical Spec: Max sounders / Max loop -zone current / Aux 28V voltage & current Changed number of repeaters that can be powered from panel from 3 to 2. Max & Min ratings in Electrical Specifications table.
1.3	8/7/2014	Corrected Charger current to 350mA. // Added addr detector wiring & addressing. // Corrected Max Battery size to 7.2Ah // Corrected wrong mention of Simplicity Panel // Corrected mention of access key Added missing “delete” in RESTORING THE PANELS DEFAULT SETTINGS section
1.4	8/7/2014	Changed “configure zone” section to reflect new menu layout // Changed “menu structure chart” Added Resound configuration info // Changed fire screen info. Added sounder fault / disablement message information
1.5	16/3/2015	Updated Enclosure drawings. Changed addressing table so that switch numbers shown from 1 to 8 (Was in binary format from 7 to 1). Added info about addressing App. // Changed max loop length from theoretical 2500 to 2000m Deleted ID2 Base configuration info. // Corrected I/O Input Configuration. Updated Verification info to include the new zonal verification option.
1.6	07/09/2015	Updated enclosure dimensions in spec table // Added missing supply fault finding information
1.7	11/12/2015	Updated I _{max} & I _{min} info to show values as seen at CIE Output
1.8	14/1/2016	Updated rating table to show max, min & nominal values. Added PSU switching frequency & Maximum ripple. Updated header to show latest F/W version.
1.9	6/4/2016	Corrected Max Battery size to 7Ah Added battery type (section 6.2.5) Corrected typo in ripple voltage 700mA -> 700mV Corrected EN54 references (Dates & revisions) Added Fuse rating table
020	1/11/2022	Added CE / UKCA table. Doc number reformatted from 1.9 to 020 to avoid ambiguity of next revision number.
021	9/2/2023	Adjusted minimum voltages in specification.
022	27/4/2023	Corrected fuse information. Added UKCA Application year in CE/UKCA Table.
023	23/6/2023	Corrected UKCA Cert No